

Wire Hardware Catalog

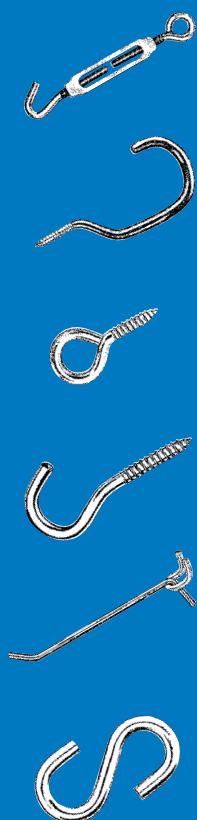

BRIGHT WIRE HARDWARE

STAINLESS STEEL HARDWARE

PEG HOOKS

STORAGE HOOKS

PLUMBING SPECIALTIES

hindley.

TABLE OF CONTENTS

ASSORTMENTS

Cotter Pin, Wire Hardware,
PegHook, Stor-All 25

BOLTS

Eye Bolts, Lag Thread 5, 10
Eye Bolts, Machine Thread 4, 9
"J" Bolts 6, 10
"U" Bolts and Square "U" Bolts 4, 8

BRACES

Screen Door Braces 13

COTTER PINS

Extended Prong, Hump 26

EYES

Screw Eyes 4, 14
Storm Window Eyes 13

HOOKS

Clothesline Hooks 18
(Lag Thread, Machine Thread,
Plate Style)
Coat & Hat Hooks 21
Cup Hooks, Brass 13
Curtain Rod Hooks 15
Gate Hooks with Eyes or Staples 17
Safety Gate Hooks 17
Hammock Hooks 19
(Lag Thread, Plate Style)
Parallel Hooks 15
Peg Hooks 22 - 24
Planter Hooks 17
Porch Swing Hooks 19
Rope Binding Hooks 11
"S" Hooks 6, 16, 26
Screw Hooks 5, 18
(Lag Thread, Machine Thread)
Screw Hooks 5, 15
(Round Bend, Square Bend)
Shoulder Hooks, Brass 13
Stor-All Hooks 20, 21, 25

PLUMBING SPECIALTIES

Closet Bolts, Closet Screws, Lift Wires
Nuts, Washers and more 7

RINGS

Hitching Rings 5, 19

SCREWS

Hand Rail Screws 10

SPECIAL WIRE FORMS

OEM, Parts made to print
and more 27

STAINLESS STEEL PRODUCTS

All Stainless Steel Products 4, 5, 6

TURNBUCKLES

Eye & Eye, Hook & Eye,
Hook & Hook 6, 12

In 1897 Walter Hindley built his company with one cotter pin machine in Valley Falls, Rhode Island. Starting with cotter keys used by the Steam Railroads last century, the company now manufactures cotter pins serving the Aerospace industry. Hindley Mfg. expanded its product line to include plumbing specialties, wire hardware, peg hooks, storage hooks and special wire forms. The third generation managing the company now distributes the wire products throughout the United States with a growing demand worldwide.

PACKAGING OPTIONS

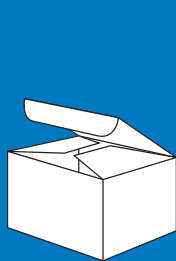

Boxed

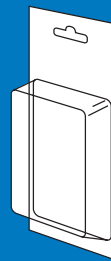

Carded



Pic-Pak

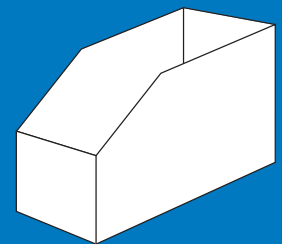

Stor-Pak

Hindley Manufacturing for over a century has earned a reputation for producing high quality hardware. In our 110,00 square foot plant located in Cumberland, Rhode Island, we use the latest wire forming technology to produce a broad range of wire hardware. Major categories include: Bright wire hardware in steel zinc and brass, Stainless Steel Hardware, Peg Hooks, Storage Hooks, Cotter Pins and Plumbing Specialties.

Hindley products can be ordered in shelf boxes or larger quantities in bulk. Many products are also available on blister cards, or in Pic-Paks and Stor-Paks. Please refer to our current Net Price Book for additional packaging information.

In addition to our standard line of wire hardware, Hindley also manufactures a wide range of wire parts for a variety of industries. For more information see page 27. Information on all our products and capabilities can also be obtained on the World Wide Web at www.hindley.com.

WARRANTY

Hindley products are covered by the following warranty:

In the event that our products or any part thereof should prove to be defective in material or workmanship, under normal use and service, and such defects are reported to us within one year from the date of shipment, we will repair or replace, at our option, whatever is necessary to eliminate the defect. We assume no responsibility for incidental or consequential damages arising from defective products. Nor do we assume any responsibility for failures, breakage, or cost which results from abuse, abnormal use, misuse, negligence, or accident or causes other than as above described.

Except as stated above, we make no warranties, either expressed or implied, as to any matter whatsoever, including, without limitation, the condition of our products, their merchantability or fitness for any particular purpose.

MAIN OFFICE

Hindley Mfg. Co., Inc.
 P.O. Box 38
 9 Havens Street
 Cumberland, RI 02864-0838
 Phone: (401) 722-2550
 Toll-Free: (800) 323-9031
 Fax: (401) 722-3083
 Internet: www.hindley.com
 E-mail: hindley@hindley.com



AMERICAN STEEL & WIRE GAUGE

Sizes of materials in this catalog are given by gauge numbers on the chart below:
 Size of wire: (A) Steel Wire Gauge No. (B) Common Fractions (C) Decimally

(A)	000	00	0	1	2	3	4	5	6	7	8	9	10	11	12	13	14	15	16	17	18	19	20							
(B)			9/32	1/4	7/32	3/16	5/32	1/8	3/32	1/16																				
(C)	.363	.328	.307	.283	.281	.262	.250	.244	.225	.219	.207	.192	.187	.177	.162	.156	.148	.135	.125	.120	.105	.094	.091	.080	.072	.062	.054	.047	.041	.034

Stainless Steel

R U S T P R O O F

STAINLESS STEEL U-BOLTS W/NUTS AND PLATES

Numbers Dimensions

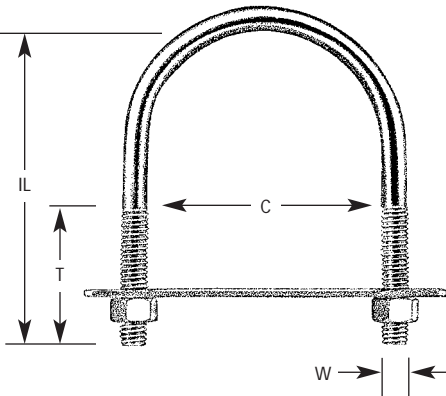

Model No.	Item No.	Width Between Legs (C)	Inside Length (IL)	Thread Length (T)	Fits Pipe Size	Wire Diameter (D)	Thread Size (W)	Pcs. Per Shelf Box	Pcs. Per Case	Lbs. Per 100 Pcs.
14417	303SS	3/4"	2 3/4"	2"	3/8"	.214	1/4-20	10	100	9.4
14421	304SS	1"	1 3/4"	1"	1/2"	.214	1/4-20	10	100	9.7
14424	308SS	1 1/8"	2 1/4"	1 1/4"	3/4"	.214	1/4-20	10	100	10.4
14426	309SS	1 3/8"	2 3/4"	1 3/4"	1"	.214	1/4-20	10	100	11.3
14427	310SS	2"	3 1/2"	1 3/4"	1 1/2"	.214	1/4-20	10	100	16.6
14430	320SS	1 3/8"	2 1/2"	1 1/4"	1"	.273	5/16-18	10	100	17.8
14431	381SS	1 3/8"	3 3/4"	2 1/8"	1"	.273	5/16-18	10	100	22.8
14433	322SS	1 3/4"	3"	1 1/2"	1 1/4"	.273	5/16-18	10	100	20.6
14435	383SS	1 3/4"	4 1/4"	2 1/2"	1 1/4"	.273	5/16-18	10	100	25.4
14436	327SS	2 1/2"	3 1/2"	1 1/2"	2"	.273	5/16-18	10	100	23.0
14470	385SS	2"	3 11/16"	2"	1 1/2"	.273	5/16-18	10	100	23.0
14441	386SS	2"	4 11/16"	2 3/4"	1 1/2"	.273	5/16-18	10	100	27.2
14443	389SS	2 1/2"	5 3/16"	3"	2"	.273	5/16-18	10	100	32.0
14437	330SS	2 1/2"	3 5/8"	1 3/4"	2"	.330	3/8-16	10	100	30.1
14438	332SS	3"	4 1/8"	1 3/4"	2 1/2"	.330	3/8-16	10	100	40.0
14439	334SS	3 1/2"	4 5/8"	2"	3"	.330	3/8-16	10	100	43.5

STAINLESS STEEL EYEBOLTS WITH NUT

Numbers Dimensions

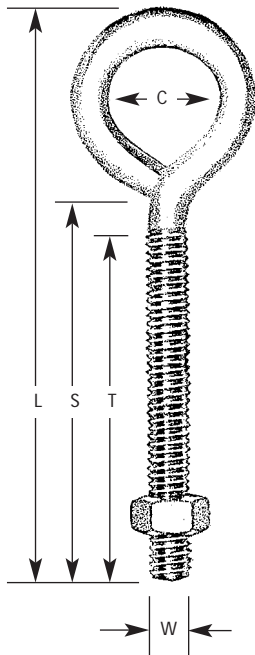

Model No.	Item No.	Thread Dia. X O.A. Length (L)	Shank Length (S)	Thread Length (T)	Inside Eye Dia. (C)	Thread Size (W)	Wire Diameter	Pcs. Per Shelf Box	Pcs. Per Case	Lbs. Per 100 Pcs.
14299	2-ASS	3/16" x 1 1/2"	3/4"	3/4"	3/8"	10-24	.160	10	100	2.4
14301	2SS	3/16" x 2"	1 5/16"	1 5/16"	5/16"	10-24	.160	10	100	2.5
14303	4-S2SS	1/4" x 2"	1"	7/8"	9/16"	1/4-20	.214	10	100	4.6
14305	4SS	1/4" x 2 5/8"	1 7/8"	1 3/4"	3/8"	1/4-20	.214	10	100	4.9
14307	4-S3SS	1/4" x 3"	2"	1 3/4"	9/16"	1/4-20	.214	10	100	5.8
14309	4-ASS	1/4" x 4"	3"	2 3/4"	9/16"	1/4-20	.214	10	100	6.8
14311	5SS	5/16" x 3 1/4"	1 7/8"	1 3/4"	1/2"	5/16-18	.273	10	100	9.4
14313	5-ASS	5/16" x 4"	2 5/8"	2 1/2"	3/4"	5/16-18	.273	10	100	11.3
14314	5-BSS	5/16" x 5"	3 1/2"	3"	3/4"	5/16-18	.273	10	100	14.0
14312	5-CSS	5/16" x 6"	4 1/2"	3"	3/4"	5/16-18	.273	10	100	13.8
14316	5-ESS	5/16" x 8"	6 1/2"	3"	3/4"	5/16-18	.273	10	100	17.1
14315	6SS	3/8" x 3 7/8"	2 1/2"	2 3/8"	5/8"	3/8-16	.332	10	100	15.9
14322	6-RSS	3/8" x 4"	2 1/4"	2"	1"	3/8-16	.332	10	100	18.0
14323	6-ASS	3/8" x 5"	3 1/4"	3"	1"	3/8-16	.332	10	100	21.0
14317	6-BSS	3/8" x 6"	4 1/4"	3"	1"	3/8-16	.332	10	100	23.9
14319	6-CSS	3/8" x 8"	6 1/4"	3 7/8"	1"	3/8-16	.332	10	100	28.6
14327	8-RSS	1/2" x 4"	1 3/4"	1 1/4"	1 1/4"	1/2-13	.445	10	100	32.7
14328	8SS	1/2" x 6"	3 3/4"	3"	1 1/4"	1/2-13	.445	10	100	44.9
14329	8-ASS	1/2" x 8"	5 3/4"	3 7/8"	1 1/4"	1/2-13	.445	10	100	50.2
14330	8-BSS	1/2" x 10"	7 3/4"	3 7/8"	1 1/4"	1/2-13	.445	10	100	59.3
14332	8-CSS	1/2" x 12"	9 3/4"	3 7/8"	1 1/4"	1/2-13	.445	10	100	71.3

STAINLESS STEEL SCREW EYES

Numbers Dimensions

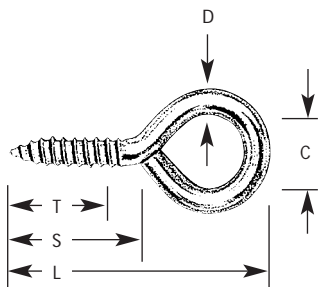

Model No.	Item No.	O.A. Length (L)	Shank Length (S)	Thread Length (T)	I.D. Eye (C)	Wire Diameter (D)	Pcs. Per Shelf Box	Pcs. Per Case	Lbs. Per 100 Pcs.
14370	OSSE	2 7/8"	1 5/16"	1 5/16"	13/16"	.307	20	200	10.2
14371	2SSE	2 5/8"	1 1/4"	1 1/8"	3/4"	.264	20	200	6.9
14372	4SSE	2 3/16"	1 1/8"	1"	5/8"	.214	20	200	4.3
14374	8SSE	1 5/8"	3/4"	5/8"	1/2"	.225	20	200	1.6

Stainless Steel

R U S T P R O O F

STAINLESS STEEL LAG THREAD EYE BOLTS

Numbers

Dimensions

Model No.	Item No.	Thread Dia. X O.A. Length (L)	Shank Length (S)	Thread Length (T)	I.D. Eye (C)	Wire Diameter (D)	Pcs. Per Shelf Box	Pcs. Per Case	Lbs. Per 100 Pcs.
14351	1100SS	3/16" x 3"	2 3/16"	1 1/8"	3/8"	.177	10	100	4.0
14352	1101SS	1/4" x 3 3/4"	2 3/4"	1 5/16"	1/2"	.244	10	100	7.1
14354	1102SS	1/4" x 5"	4"	1 3/4"	1/2"	.244	10	100	8.2
14356	1103SS	5/16" x 4"	2 3/4"	1 3/4"	5/8"	.307	10	100	11.5
14357	1103BSS	5/16" x 5"	3 3/4"	1 3/4"	5/8"	.307	10	100	14.2
14358	1104SS	5/16" x 6"	4 3/4"	1 3/4"	5/8"	.307	10	100	17.2
14360	1105SS	3/8" x 4 1/2"	2 3/4"	1 3/4"	3/4"	.365	10	100	19.4
14361	1105DSS	3/8" x 6"	4 1/4"	1 3/4"	3/4"	.365	10	100	23.7
14362	1106SS	3/8" x 8"	6 1/4"	2 7/8"	3/4"	.365	10	100	29.2
14363	1107SS	7/16" x 5 1/4"	3 1/4"	2 1/2"	1"	.445	10	100	34.2

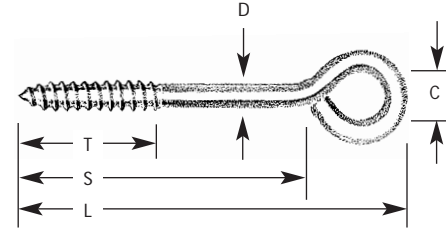

STAINLESS STEEL SCREW HOOKS Lag Thread

Numbers

Dimensions

Model No.	Item No.	O.A. Length (L)	Shank Length (S)	Thread Length (T)	Hook Opening (E)	Wire Diameter (D)	Pcs. Per Shelf Box	Pcs. Per Case	Lbs. Per 100 Pcs.
14568	802SS	4 7/16"	2 1/2"	1 1/2"	1"	.264	10	100	9.2
14569	803SS	4 1/8"	2 1/2"	1 3/4"	15/16"	.244	10	100	7.5
14570	804SS	3 7/8"	2 3/8"	1 1/2"	13/16"	.223	20	200	5.8
14571	806SS	3 3/8"	2"	7/8"	3/4"	.192	20	200	3.8
14572	808SS	2 9/16"	1 3/8"	7/8"	9/16"	.160	20	200	1.9
14573	810SS	2 1/16"	1 1/4"	11/16"	3/8"	.135	20	200	1.1
14574	812SS	1"	1"	5/8"	13/16"	.105	50	500	0.5
14575	814SS	1 5/16"	7/8"	1/2"	1/4"	.080	50	500	0.3
14600	324-5/16SS	4 1/2"	2 3/4"	1 3/4"	1"	.307	10	100	12.4
14599	324-3/8SS	4 7/8"	2 3/4"	1 3/4"	1 1/16"	.332	10	100	20.5

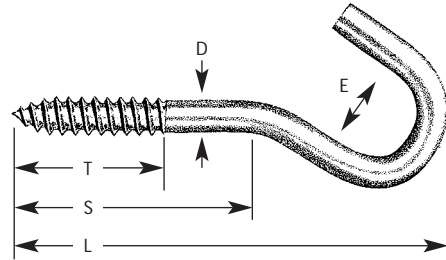

STAINLESS STEEL SCREW HOOKS Machine Thread with Nut

Numbers

Dimensions

Model No.	Item No.	O.A. Length (L)	Thread Length (T)	Hook Opening (E)	Thread Size (W)	Wire Diameter (D)	Pcs. Per Shelf Box	Pcs. Per Case	Lbs. Per 100 Pcs.
14530	614-5/32SS	1 5/8"	1"	1/4"	8-32	.141	10	100	1.5
14531	614-3/16SS	2"	1 1/4"	5/16"	10-24	.160	10	100	1.9
14532	614-7/32SS	2 3/8"	1 3/8"	3/8"	12-24	.186	10	100	2.4
14533	614-1/4SS	2 5/8"	1 9/16"	3/8"	1/4-20	.214	10	100	4.0
14534	614-5/16SS	3 1/4"	1 3/4"	5/8"	5/16-18	.273	10	100	8.4
14535	614-3/8SS	3 7/8"	2 3/8"	1 1/16"	3/8-16	.332	10	100	13.6

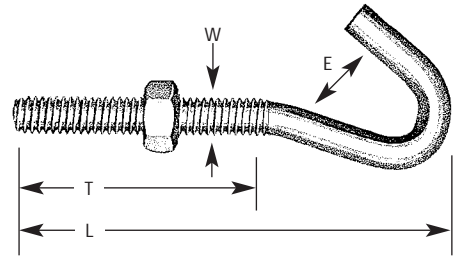

STAINLESS STEEL HITCHING RINGS Machine Thread with Hex Nut

Numbers

Dimensions

Model No.	Item No.	Shank Length (S)	Thread Length (T)	Wire Diameter (D)	Thread Size (W)	Ring Wire Diameter	Ring Diameter	Pcs. Per Shelf Box	Pcs. Per Case	Lbs. Per 100 Pcs.
14519	34-2 1/2SS	2 1/2"	2"	.330	3/8-16	.307	2"	10	100	28.0
14522	34-4SS	4"	3"	.330	3/8-16	.307	2"	10	100	32.0
14523	34-6SS	6"	4"	.330	3/8-16	.307	2"	10	100	35.0

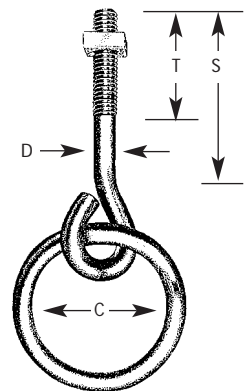

Stainless Steel

R U S T P R O O F

STAINLESS STEEL TURNBUCKLES W/ALUMINUM BODIES - EYE & EYE, HOOK & EYE

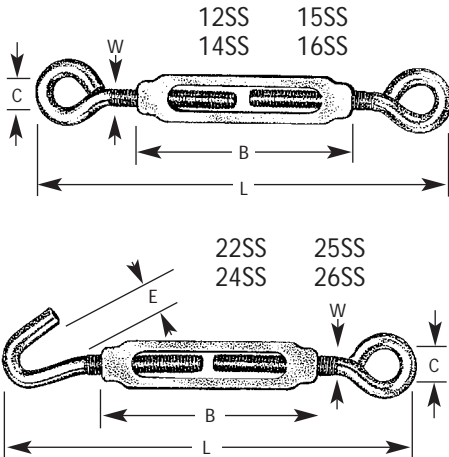

Numbers		Dimensions										
Model No.	Item No.	O.A. Closed (L)	O.A. Open	Take Up	Body O.A. Length	I.D. Eye (C)	Hook Opening (E)	Thread Size (W)	Wire Diameter (D)	Pcs. Per Shelf Box	Pcs. Per Case	Lbs. Per 100 Pcs.
14485	12SS	4"	5 5/8"	1 5/8"	2 1/8"	5/16"	-	3/16"	.160	10	100	6.0
14487	14SS	5 1/4"	7 3/8"	2 1/8"	2 7/8"	3/8"	-	1/4"	.214	10	100	13.1
14488	15SS	6 1/2"	9 1/8"	2 5/8"	3 1/2"	1/2"	-	5/16"	.273	10	100	22.5
14489	16SS	7 3/4"	10 1/2"	3"	4 1/8"	5/8"	-	3/8"	.332	10	100	35.5
14495	22SS	4"	5 5/8"	1 5/8"	2 1/8"	5/16"	5/16"	3/16"	.160	10	100	6.0
14497	24SS	5 1/4"	7 3/8"	2 1/8"	2 7/8"	3/8"	3/8"	1/4"	.214	10	100	13.1
14498	25SS	6 1/2"	9 1/8"	2 5/8"	3 1/2"	1/2"	5/8"	5/16"	.273	10	100	22.5
14499	26SS	7 3/4"	10 1/2"	3"	4 1/8"	5/8"	11/16"	3/8"	.332	10	100	35.5

STAINLESS STEEL J-BOLTS WITH NUT

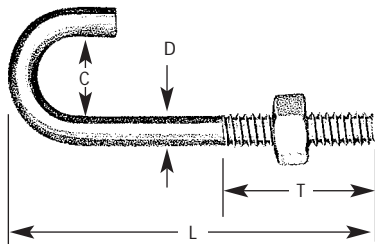

Numbers		Dimensions							
Model No.	Item No.	O.A. Length (L)	Thread Length (T)	Inside Hook Dia. (C)	Wire Diameter (D)	Thread Size	Pcs. Per Shelf Box	Pcs. Per Case	Lbs. Per 100 Pcs.
14688	J5-3SS	3"	1 7/8"	5/8"	.272	5/16-18	10	100	7.5
14689	J5-5SS	5"	2 1/2"	5/8"	.272	5/16-18	10	100	11.2
14691	J5-7SS	7"	3 7/8"	7/8"	.272	5/16-18	10	100	15.0
14693	J6-3 3/4SS	3 3/4"	2 1/4"	3/4"	.332	3/8-16	10	100	15.0
14694	J6-5SS	5"	2 1/4"	3/4"	.332	3/8-16	10	100	18.0
14696	J6-7SS	7"	2 1/4"	3/4"	.332	3/8-16	10	100	22.8

STAINLESS STEEL S-HOOKS Heavy Open Style

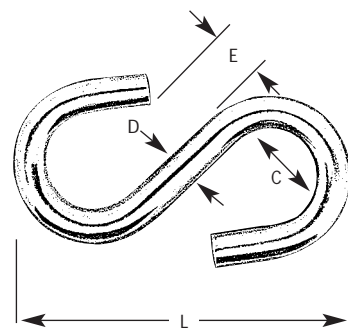

Numbers		Dimensions						
Model No.	Item No.	O.A. Length (L)	Eye Dia. (C)	Opening (E)	Wire Diameter (D)	Pcs. Per Shelf Box	Pcs. Per Case	Lbs. Per 100 Pcs.
14537	28HSS	3/4"	3/16"	3/16"	.092	50	500	0.3
14538	29HSS	1"	1/4"	3/16"	.120	50	500	0.7
14539	30HSS	1 1/4"	3/8"	1/4"	.148	20	200	1.3
14540	31SS	1 1/2"	7/16"	1/4"	.177	20	200	2.4
14542	32SS	1 3/4"	1/2"	5/16"	.177	20	200	2.9
14544	33SS	2"	9/16"	3/8"	.250	20	200	7.0
14546	34SS	2 1/4"	5/8"	5/16"	.250	20	200	7.6
14548	35SS	2 1/2"	3/4"	7/16"	.307	20	200	11.3
14550	36SS	3"	7/8"	1/2"	.307	10	100	13.4

STAINLESS STEEL S-HOOKS Light Open Style

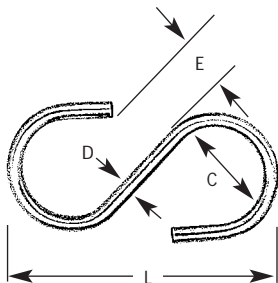

Numbers		Dimensions						
Model No.	Item No.	O.A. Length (L)	Eye Diameter (C)	Opening (E)	Wire Diameter (D)	Pcs. Per Shelf Box	Pcs. Per Case	Lbs. Per 100 Pcs.
14565	10LSS	1 3/4"	5/8"	5/16"	.105	50	500	1.0
14564	20LSS	1 1/2"	1/2"	1/4"	.105	50	500	0.9
14563	30LSS	1 1/4"	3/8"	1/4"	.105	50	500	0.7
14562	40LSS	1"	5/16"	3/16"	.092	50	500	0.4
14561	50LSS	7/8"	1/4"	3/16"	.092	50	500	0.3
14560	60LSS	3/4"	1/4"	1/8"	.080	50	500	0.3

Plumbing Specialties

Hindley has served the plumbing and hardware wholesaler for years with the finest in brass and copper plumbing specialties. See our current Net Price Book for all the details on packaging, price and other items not shown here.

CLOSET BOLTS

Numbers		Dimensions	
Material	Thread Size	Lengths	Pcs. Per Box
Plated Steel	1/4-20	1 3/4", 2 1/4", 3 1/2"	100
Plated Steel	5/16-18	2 1/4"	100
Brass	1/4-20	1 3/4", 2 1/4", 3 1/2"	100
Brass	5/16-18	1 3/4", 2 1/4", 3 1/2"	100

CLOSET BOLT NUTS

 Open

Numbers		Dimensions	
Material	Thread Size	Lengths	Pcs. Per Box
Brass-Nickel & Chrome Plated	1/4-20	7/16", 1/2"	100
Brass-Nickel & Chrome Plated	5/16-18	1/2"	100

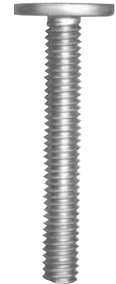

CLOSET SCREWS

Numbers		Dimensions	
Material	Thread Size	Lengths	Pcs. Per Box
Plated Steel	1/4-20	2 1/2"	100
Plated Steel	5/16-18	2 1/2", 3 1/2"	100
Brass	1/4-20	2 1/2", 3", 3 1/2"	100
Brass	5/16-18	2 1/2", 3 1/2"	100

CLOSET SCREW NUTS

 Closed

Numbers		Dimensions	
Material	Thread Size	Lengths	Pcs. Per Box
Brass-Nickel & Chrome Plated	1/4-20	7/16", 1/2"	100
Brass-Nickel & Chrome Plated	5/16-18	1/2"	100



CLOSET BOLT AND CLOSET SCREW COMBINATIONS

Packaged 10 Poly-Pak bag sets per box, all closet bolt and closet screw sizes are packed in combination with nuts and washers. Choose between solid brass or plated steel with nickel or chrome plated brass nuts and light or heavy washers.

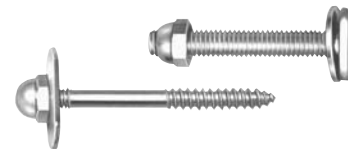

SHOWER CURTAIN PINS

For 1" Rod

Numbers		Dimensions	
Material	Wire Size	Plating	Pcs. Per Box
Brass	.091	Chrome	100
Steel	.091	Nickel	100
Steel	.091	Zinc Chromate	100

Available in Poly-Pak bags, 12 per bag, 10 bags per box.

WASHERS

Round & Oval

Numbers		Dimensions	
Material	Size Diameter	Pcs. Per Box	
Brass-Nickel Plated	.020	100	
Brass-Nickel Plated	.050	100	
Stainless Steel	.050	100	



LOWER LIFT WIRES

Numbers		Dimensions		
Material	Thread Size	Lengths	Thread Length	Pcs. Per Box
Brass	6-32	4 1/2", 5", 5 1/2", 6"	9/32"	100
Copper	6-32	4 1/2", 5", 5 1/2", 6"	9/32"	100

UPPER LIFT WIRES

Numbers		Dimensions	
Material	Wire Diameter	Lengths	Pcs. Per Box
Brass	.105	8", 8 1/2", 9", 10"	100
Copper	.105	8", 8 1/2", 9", 10"	100

CLOSE COUPLED BOLT COMBINATIONS

Numbers		Dimensions	
Material	Thread Size	Lengths	Poly-Pak Sets Per Box
Brass	5/16-18	2 1/2", 3 1/4"	25
Brass	5/16-18	3 1/4"	25
Brass	3/8-16	3 1/8"	25

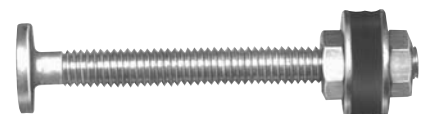

U-Bolts

STANDARD STYLE
EXTRA LONG STYLE
SQUARE STYLE

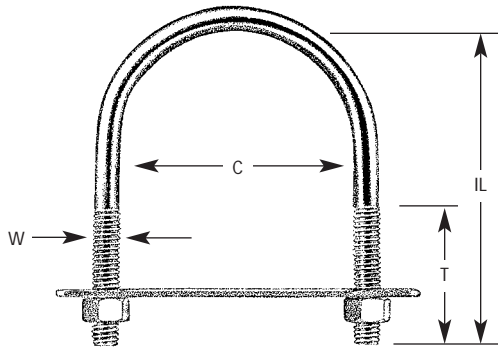

All U-Bolts are provided with hex nuts and straps assembled for your convenience.

Zinc Chromate finish.

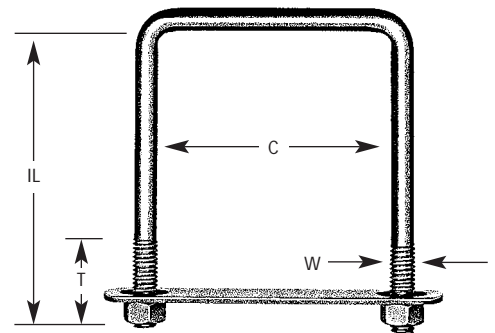

Numbers

Dimensions

Model No.	Zinc Chromate Number	Alternate Number	Width Between Legs (C)	Inside Length (IL)	Thread Length (T)	Fits Pipe Size	Wire Diameter	Thread Size (W)	Pcs. Per Shelf Box	Pcs. Per Case	Lbs. Per 100 Pcs.
STANDARD STYLE											
11276	301		9/16"	1 3/8"	3/4"	1/4"	.214	1/4-20	10	100	7.8
11161	60C		3/4"	1 1/4"	3/4"	3/8"	.214	1/4-20	10	100	8.1
11162	61C	302	3/4"	1 3/4"	1"	3/8"	.214	1/4-20	10	100	9.8
11164	63C		3/4"	2 3/4"	2"	3/8"	.214	1/4-20	10	100	11.1
11167	66C	304	1"	1 3/4"	1"	1/2"	.214	1/4-20	10	100	9.1
11168	67C	308	1 1/8"	2 1/4"	1 1/2"	3/4"	.214	1/4-20	10	100	10.4
11169	68C	309	1 3/8"	2 3/4"	1 3/4"	1"	.214	1/4-20	10	100	13.5
11170	69C		1 3/4"	2 3/4"	1 1/4"	1 1/4"	.214	1/4-20	10	100	14.1
11171	70C	310	2"	3 1/2"	1 3/4"	1 1/2"	.214	1/4-20	10	100	16.1
11196	80C	320	1 3/8"	2 1/2"	1 1/4"	1"	.272	5/16-18	10	100	17.1
11197	82C	322	1 3/4"	3"	1 1/2"	1 1/4"	.272	5/16-18	10	100	20.6
11198	84C	324	2"	3 1/4"	1 1/2"	1 1/2"	.272	5/16-18	10	100	21.0
11199	85C	385	2"	3 11/16"	2"	1 1/2"	.272	5/16-18	10	100	24.1
11200	87C	327	2 1/2"	3 1/2"	1 1/2"	2"	.272	5/16-18	10	100	23.0
11201	88C	338	2 1/2"	4 3/16"	2 1/4"	2"	.272	5/16-18	10	100	26.5
11226	90C	329 1/2	2"	3 1/8"	1 1/2"	1 1/2"	.331	3/8-16	10	100	30.5
11227	91C	330	2 1/2"	3 5/8"	1 3/4"	2"	.331	3/8-16	10	100	33.1
11228	92C	332	3"	4 1/8"	1 3/4"	2 1/2"	.331	3/8-16	10	100	43.7
11229	93C	334	3 1/2"	4 5/8"	2"	3"	.331	3/8-16	10	100	47.7
11230	94C	340	3"	5"	2 1/2"	2 1/2"	.445	1/2-13	10	100	89.0
11231	95C	342	3 1/2"	5 1/2"	2 1/2"	3"	.445	1/2-13	10	100	88.0
11232	96C	343	4"	6"	2 1/2"	3 1/2"	.445	1/2-13	10	100	94.4
11233	97C	344	4 1/2"	6 1/2"	2 1/2"	4"	.445	1/2-13	10	100	95.3
EXTRA LONG STYLE											
11254	67CL		1 1/8"	3 1/2"	2 3/4"	3/4"	.214	1/4-20	10	100	13.1
11255	81CL	381	1 3/8"	3 3/4"	2 1/8"	1"	.272	5/16-18	10	100	22.1
11256	83CL	383	1 3/4"	4 1/4"	2 1/2"	1 1/4"	.272	5/16-18	10	100	25.1
11257	86CL	386	2"	4 11/16"	2 3/4"	1 1/2"	.272	5/16-18	10	100	27.4
11258	89CL	389	2 1/2"	5 3/16"	3"	2"	.272	5/16-18	10	100	32.0
11260	93CL		3 1/2"	6 1/2"	3"	3"	.331	3/8-16	10	100	59.1
SQUARE STYLE											
11302	823C		2"	3"	1 1/2"		.272	5/16-18	10	100	22.0
11304	825C		2"	5"	3"		.272	5/16-18	10	100	29.0
11306	827C		2"	7"	3 3/4"		.272	5/16-18	10	100	37.0
11308	934C		3"	4"	2"		.331	3/8-16	10	100	44.4
11310	936C		3"	6"	3 1/2"		.331	3/8-16	10	100	55.4
11312	937C		3"	7"	3 3/4"		.331	3/8-16	10	100	59.4
11314	943C		4"	3"	1 1/2"		.331	3/8-16	10	100	45.7
11316	945C		4"	5"	3"		.331	3/8-16	10	100	55.7
11318	946C		4"	6"	3 1/2"		.331	3/8-16	10	100	59.7

SMALL EYE
REGULAR EYE
WELDED EYE

Eye Bolts

All Eye Bolts are provided
with hex nuts assembled
for your convenience.

Zinc Chromate finish.

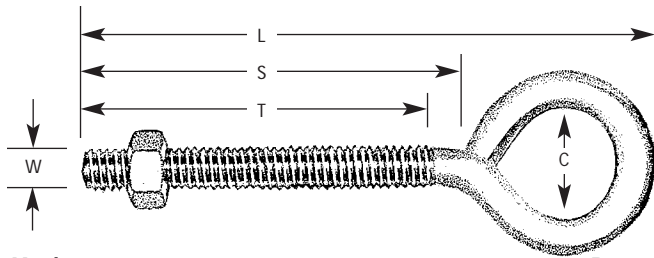

Numbers

Dimensions

Model No.	Zinc Chromate Number	(Thread Dia. (D) x O.A. Length(L))	Alternate Number	Shank Length (S)	Thread Length (T)	Inside Eye Dia. (C)	Thread Size (W)	Wire Diameter	Pcs. Per Shelf Box	Pcs. Per Case	Lbs. Per 100 Pcs.
SMALL EYE											
10704	514S	5/32" x 1 5/8"	1	1 1/8"	1"	1/4"	8-32	.141	20	200	1.6
10706	514S	3/16" x 2"	2	1 5/16"	1 5/16"	5/16"	10-24	.160	20	200	2.2
10707	514S	7/32" x 2 3/8"	3	1 1/2"	1 3/8"	3/8"	12-24	.186	20	200	3.4
10708	514S	1/4" x 2 5/8"	4	1 7/8"	1 3/4"	3/8"	1/4-20	.214	20	200	4.0
10709	514S	5/16" x 3 1/4"	5	2 1/8"	2"	1/2"	5/16-18	.272	10	100	10.0
10710	514S	3/8" x 3 7/8"	6	2 1/2"	2 3/8"	5/8"	3/8-16	.331	10	100	15.9
REGULAR EYE											
10769	514	3/16" x 1 3/4"	2A	1"	7/8"	3/8"	10-24	.160	20	200	2.2
10771	514	3/16" x 2 1/4"	2B	1 1/2"	1 3/8"	3/8"	10-24	.160	20	200	2.4
10772	514	3/16" x 2 1/2"	2S	1 3/4"	1 5/8"	3/8"	10-24	.160	20	200	2.7
10773	514	3/16" x 2 3/4"	2C	2"	1 7/8"	3/8"	10-24	.160	20	200	2.9
10774	514	3/16" x 3"	2D	2 1/4"	2 1/8"	3/8"	10-24	.160	20	200	3.2
10800	514	1/4" x 2"	4R1	1"	7/8"	9/16"	1/4-20	.214	20	200	4.6
10802	514	1/4" x 2 1/2"	4R2	1 1/2"	1 1/4"	9/16"	1/4-20	.214	20	200	5.1
10803	514	1/4" x 3"	4R3	2"	1 3/4"	9/16"	1/4-20	.214	20	200	5.8
10805	514	1/4" x 4"	4A	3"	2 3/4"	9/16"	1/4-20	.214	20	200	6.8
10807	514	1/4" x 5"	4B	4"	3"	9/16"	1/4-20	.214	20	200	7.5
10808	514	1/4" x 6"	4C	5"	3"	9/16"	1/4-20	.214	20	200	8.9
10810	514	1/4" x 8"	4E	7"	3"	9/16"	1/4-20	.214	20	200	11.5
10836	514	5/16" x 2 1/4"	5S	3/4"	1/2"	3/4"	5/16-18	.272	10	100	7.7
10839	514	5/16" x 3 1/4"	5R	1 3/4"	1 1/2"	3/4"	5/16-18	.272	10	100	10.3
10841	514	5/16" x 4"	5A	2 1/2"	2 1/4"	3/4"	5/16-18	.272	10	100	12.0
10843	514	5/16" x 5"	5B	3 1/2"	3"	3/4"	5/16-18	.272	10	100	14.0
10845	514	5/16" x 6"	5C	4 1/2"	3"	3/4"	5/16-18	.272	10	100	14.9
10849	514	5/16" x 8"	5E	6 1/2"	3"	3/4"	5/16-18	.272	10	100	18.7
10873	514	3/8" x 2 1/2"	6S	3/4"	1/2"	1"	3/8-16	.331	10	100	14.5
10875	514	3/8" x 4"	6R	2 1/4"	2"	1"	3/8-16	.331	10	100	18.4
10877	514	3/8" x 5"	6A	3 1/4"	3"	1"	3/8-16	.331	10	100	21.1
10878	514	3/8" x 6"	6B	4 1/4"	3"	1"	3/8-16	.331	10	100	23.9
10880	514	3/8" x 8"	6C	6 1/4"	3 7/8"	1"	3/8-16	.331	10	100	28.0
10907	514	7/16" x 8"	7A	6"	3"	1 1/8"	7/16-14	.380	10	100	40.0
10932	514	1/2" x 4"	8R	1 3/4"	1 1/4"	1 1/4"	1/2-13	.445	10	100	36.1
10934	514	1/2" x 6"	8	3 3/4"	3"	1 1/4"	1/2-13	.445	10	100	44.9
10936	514	1/2" x 8"	8A	5 3/4"	3 7/8"	1 1/4"	1/2-13	.445	10	100	55.0
10938	514	1/2" x 10"	8B	7 3/4"	3 7/8"	1 1/4"	1/2-13	.445	10	100	62.9
10940	514	1/2" x 12"	8C	9 3/4"	3 7/8"	1 1/4"	1/2-13	.445	10	100	71.3
WELDED EYE											
13802	514W	1/4" x 2 1/2"	W4R2	1 1/2"	1 3/8"	9/16"	1/4-20	.214	10	100	5.1
13841	514W	5/16" x 4"	W5A	2 1/2"	2 1/4"	3/4"	5/16-18	.272	10	100	12.0
13845	514W	5/16" x 6"	W5C	4 1/2"	3"	3/4"	5/16-18	.272	10	100	15.2
13875	514W	3/8" x 4"	W6R	2 1/4"	2"	1"	3/8-16	.331	10	100	18.0
13878	514W	3/8" x 6"	W6B	4 1/4"	3"	1"	3/8-16	.331	10	100	24.1
13880	514W	3/8" x 8"	W6C	6 1/4"	3 7/8"	1"	3/8-16	.331	10	100	28.4
13934	514W	1/2" x 6"	W8	3 3/4"	3"	1 1/4"	1/2-13	.445	10	100	44.4
13938	514W	1/2" x 10"	W8B	7 3/4"	3 7/8"	1 1/4"	1/2-13	.445	10	100	62.9

Bolts & Screws

J - BOLTS
EYE BOLTS
HAND RAIL SCREWS

J - BOLTS Zinc Chromate finish

Numbers

Dimensions

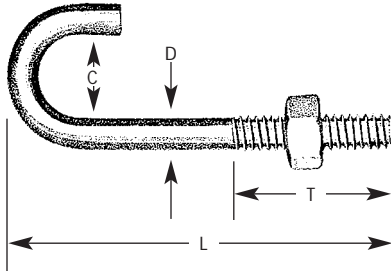

Model No.	Zinc Chromate No.	Overall Length (L)	Thread Length (T)	Inside Hook Dia. (C)	Wire Dia. (D)	Thread Size	Pcs. Per Shelf Box	Pcs. Per Case	Lbs. Per 100 Pcs.
11020	J1-1 7/8	1 7/8"	1 1/4"	5/16"	.141	8-32	20	200	1.9
11022	J2-2 1/8	2 1/8"	1 1/4"	3/8"	.160	10-24	20	200	2.5
11024	J4-2 5/16	2 5/16"	1 1/2"	7/16"	.214	1/4-20	20	200	4.4
11036	J4-4	4 "	2 "	1/2"	.214	1/4-20	20	200	7.0
11038	J4-6	6 "	2 1/2"	5/8"	.214	1/4-20	20	200	9.4
11026	J5-3	3 "	1 7/8"	5/8"	.272	5/16-18	10	100	8.8
11040	J5-5	5 "	2 1/2"	5/8"	.272	5/16-18	10	100	12.8
11042	J5-7	7 "	3 7/8"	5/8"	.272	5/16-18	10	100	17.3
11028	J6-3 3/4	3 3/4"	2 1/4"	5/8"	.331	3/8-16	10	100	15.0
11030	J6-5	5 "	2 1/4"	5/8"	.331	3/8-16	10	100	17.5
11032	J6-7	7 "	3 7/8"	5/8"	.331	3/8-16	10	100	23.8
11034	J8-6	6 "	3 "	1 "	.445	1/2-13	10	100	40.0

All J-Bolts are provided with hex nuts assembled for your convenience.

EYE BOLTS - LAG SCREW THREAD Zinc Chromate finish

Numbers

Dimensions

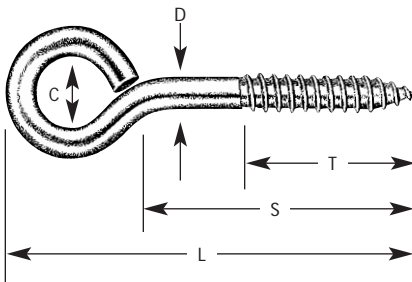

Model No.	Zinc Chromate (Thread Dia. X O.A. Length (L))	Alternate Number	Shank Length (S)	Thread Length (T)	I.D. Eye (C)	Wire Dia. (D)	Pcs. Per Shelf Box	Pcs. Per Case	Lbs. Per 100 Pcs.
11090	414 3/16 x 3	1100	2 3/16"	1 1/8"	3/8"	.177	20	200	4.0
11101	414 1/4 x 3 3/4	1101	2 3/4"	1 3/4"	1/2"	.244	20	200	7.1
11103	414 1/4 x 5	1102	4 "	1 7/8"	1/2"	.244	20	200	8.9
11104	414 5/16 x 4	1103	2 3/4"	1 3/4"	5/8"	.307	10	100	12.3
11093	414 5/16 x 5	1103-B	3 3/4"	1 3/4"	5/8"	.307	10	100	16.0
11105	414 5/16 x 6	1104	4 3/4"	1 3/4"	5/8"	.307	10	100	16.6
11106	414 3/8 x 4 1/2	1105	2 3/4"	1 3/4"	3/4"	.365	10	100	19.4
11095	414 3/8 x 6	1105-D	4 1/4"	1 3/4"	3/4"	.365	10	100	25.0
11107	414 3/8 x 8	1106	6 1/4"	2 7/8"	3/4"	.365	10	100	31.0
11108	414 7/16 x 5 1/4	1107	3 1/4"	2 1/2"	1 "	.445	10	100	34.1

HAND RAIL SCREWS Zinc Chromate finish

Numbers

Dimensions

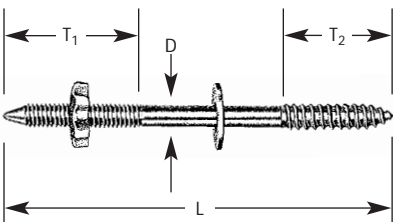

Model No.	Zinc Chromate Number (Thread Dia. (D) X O.A. Length (L))	5/16-18 Machine Thread (T ₁)	Wood Screw Thread (T ₂)	Wire Dia.	Pcs. Per Box	Pcs. Per Case	Lbs. Per 100 Pcs.
12659	551 5/16" x 3 1/2"	1 5/8"	1 1/2"	.272	50	500	7.7
12660	551 5/16" x 4"	1 3/4"	1 1/2"	.272	50	500	9.4
12661	551 5/16" x 4 1/2"	1 3/4"	1 1/2"	.272	50	500	10.3
12662	551 5/16" x 5"	1 3/4"	1 1/2"	.272	50	500	11.4

Each screw is supplied with 5/16 - 18 cog nut and washer (3/8" I.D., 11/16" O.D. and .078 thick).

OPEN HOOK - ROPE BINDING HOOKS

Zinc Chromate finish

Numbers

Dimensions

Model No.	Product No.	O.A. Length (L)	Hook Opening (E)	Hook Length (N)	Width (W)	Thickness (G)	Dia. of Holes (H)	Wire Diameter (D)	Pcs. Per Shelf Box	Pcs. Per Case	Lbs. Per 100 Pcs.
11990	52C	1 1/2"	7/16"	5/8"	5/16"	3/32"	5/32"	.192	10	100	1.9
11991	53C	2 1/16"	5/8"	15/16"	7/16"	1/8"	3/16"	.250	10	100	4.6
11992	54C	2 5/8"	3/4"	1"	1/2"	5/32"	3/16"	.307	10	100	8.4
11993	55C	3 3/4"	1"	1 5/8"	9/16"	3/16"	1/4"	.365	10	100	16.4
11997	57C	4 7/8"	1 1/8"	1 3/4"	5/8"	3/16"	5/16"	.365	10	100	21.8
11998	58C	5 1/8"	1 1/4"	1 3/4"	13/16"	7/32"	3/8"	.445	10	100	32.0

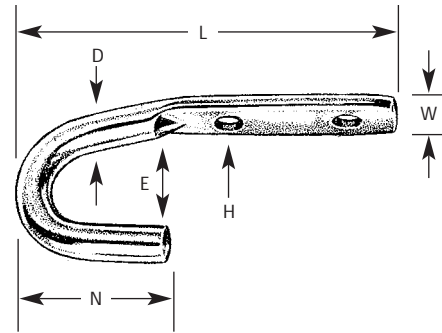

LOOP STYLE - ROPE BINDING HOOKS

Zinc Chromate finish

Numbers

Dimensions

Model No.	Product No.	O. A. Length (L)	Dia. Loop Eye	Flat Length (N)	Width (W)	Thickness (G)	Dia. of Holes (H)	Wire Diameter (D)	Pcs. Per Shelf Box	Pcs. Per Case	Lbs. Per 100 Pcs.
11995	56C	4 3/16"	1"	2 1/8"	1/2"	.170	3/16"	.330	10	100	18.0

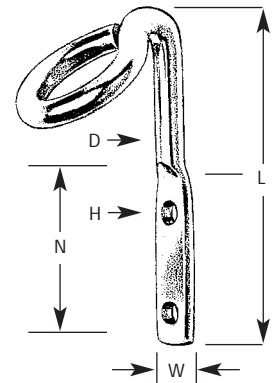

SNAP-BACK STYLE - ROPE BINDING HOOKS

This spring actuated hook lies flat, out of the way when not in use. A rugged, coiled spring holds hook down under constant tension. Hook pivots a full 180° permitting it to be mounted for maximum efficiency and ease of use.

Numbers

Dimensions

Zinc Chromate finish

Model No.	Product No.	Hook Opening (E)	Hook Length (N)	Dia. of Holes (H)	Wire Diameter (D)	Pcs. Per Shelf Box	Pcs. Per Case	Lbs. Per 100 Pcs.
12000	54S	3/4"	1 7/8"	1/4"	.312	10	100	18.8

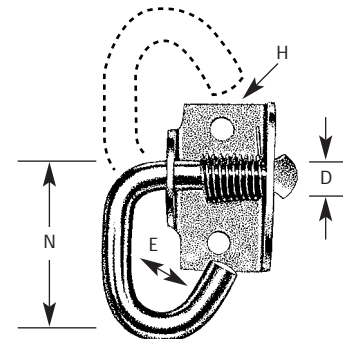

Turnbuckles

EYE & EYE
HOOK & EYE
HOOK & HOOK

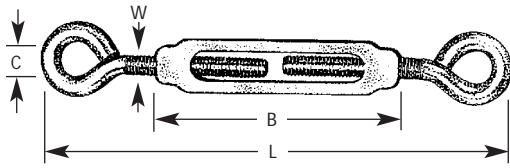

TURNBUCKLES - EYE & EYE

Extruded Aluminum Bodies with Zinc Chromate Steel Eyes

Numbers

Dimensions

Model No.	Item Eye	O.A. Closed (L)	O.A. Open	Take Up	Body O.A. Length (B)	I.D. Eye (C)	Thread Dia. (W)	Wire Diameter	Pcs. Per Shelf Box	Pcs. Per Case	Lbs. Per 100 Pcs.
11369	11	3 1/4"	4 1/2"	1 1/4"	1 3/4"	1/4"	5/32"	.141	10	100	3.1
11370	12	4"	5 5/8"	1 5/8"	2 1/8"	5/16"	3/16"	.160	10	100	4.6
11371	13	4 3/4"	6 5/8"	1 7/8"	2 1/2"	3/8"	7/32"	.186	10	100	7.2
11372	14	5 1/4"	7 3/8"	2 1/8"	2 7/8"	3/8"	1/4"	.214	10	100	10.6
11373	15	6 1/2"	9 1/8"	2 5/8"	3 1/2"	1/2"	5/16"	.272	10	100	20.0
11374	16	7 3/4"	10 1/2"	3"	4 1/8"	5/8"	3/8"	.331	10	100	35.0
11375	17	10 1/8"	15 1/8"	5"	6 1/8"	5/8"	3/8"	.331	10	100	43.5

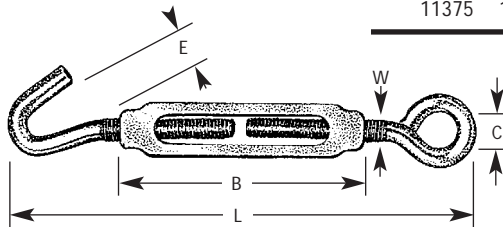

TURNBUCKLES - HOOK & EYE

Extruded Aluminum Bodies with Zinc Chromate Steel Eyes and Hooks

Numbers

Dimensions

Model No.	Item Eye	O.A. Closed (L)	O.A. Open	Take Up	Body O.A. Length (B)	I.D. Eye (C)	Hook Opening (E)	Thread Dia. (W)	Wire Diameter	Pcs. Per Shelf Box	Pcs. Per Case	Lbs. Per 100 Pcs.
11400	21	3 1/4"	4 1/2"	1 1/4"	1 3/4"	1/4"	1/4"	5/32"	.141	10	100	3.0
11401	22	4"	5 5/8"	1 5/8"	2 1/8"	5/16"	5/16"	3/16"	.160	10	100	4.6
11402	23	4 3/4"	6 5/8"	1 7/8"	2 1/2"	3/8"	3/8"	7/32"	.186	10	100	7.1
11403	24	5 1/4"	7 3/8"	2 1/8"	2 7/8"	3/8"	3/8"	1/4"	.214	10	100	10.5
11404	25	6 1/2"	9 1/8"	2 5/8"	3 1/2"	1/2"	5/8"	5/16"	.272	10	100	20.0
11405	26	7 3/4"	10 1/2"	3"	4 1/8"	5/8"	11/16"	3/8"	.331	10	100	34.2
11406	27	10 1/8"	15 1/8"	5"	6 1/8"	5/8"	11/16"	3/8"	.331	10	100	43.1

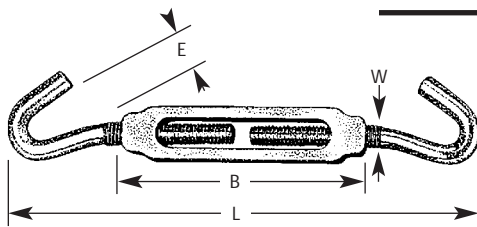

TURNBUCKLES - HOOK & HOOK

Extruded Aluminum Bodies with Zinc Chromate Steel Hooks

Numbers

Dimensions

Model No.	Item Eye	O.A. Closed (L)	O.A. Open	Take Up	Body O.A. Length (B)	Hook Opening (E)	Thread Dia. (W)	Wire Diameter	Pcs. Per Shelf Box	Pcs. Per Case	Lbs. Per 100 Pcs.
11431	31	3 1/4"	4 1/2"	1 1/4"	1 3/4"	1/4"	5/32"	.141	10	100	3.0
11432	32	4"	5 5/8"	1 5/8"	2 1/8"	5/16"	3/16"	.160	10	100	4.6
11433	33	4 3/4"	6 5/8"	1 7/8"	2 1/2"	3/8"	7/32"	.186	10	100	7.1
11434	34	5 1/4"	7 3/8"	2 1/8"	2 7/8"	3/8"	1/4"	.214	10	100	10.4
11435	35	6 1/2"	9 1/8"	2 5/8"	3 1/2"	5/8"	5/16"	.272	10	100	20.0
11436	36	7 3/4"	10 1/2"	3"	4 1/8"	11/16"	3/8"	.331	10	100	33.4
11437	37	10 1/8"	15 1/8"	5"	6 1/8"	11/16"	3/8"	.331	10	100	42.8

Note: Product Number for Turnbuckle Eye Bolts 514S (See p.9) and Product Number for Turnbuckle Hooks is 614 (See p.18)

CUP HOOKS
 SHOULDER HOOKS
 STORM WINDOW EYES
 SCREEN DOOR BRACE

Hooks & Eyes

CUP HOOKS IN SOLID BRASS

Numbers		Dimensions						
Model No.	Solid Brass Number	O.A. Length (L)	Thread Length (T)	Wire Diameter (D)	Opening (E)	Pcs. Per Shelf Box	Pcs. Per Case	Lbs. Per 100 Pcs.
11925	981-1/2	7/8"	3/16"	.072	3/16"	100	1000	0.25
11926	981-5/8	1"	1/4"	.080	1/4"	100	1000	0.28
11927	981-3/4	1 1/8"	1/4"	.091	5/16"	100	1000	0.44
11928	981-7/8	1 3/8"	5/16"	.105	3/8"	100	1000	0.63
11929	981-1	1 1/2"	5/16"	.120	7/16"	100	1000	0.94
11931	981-1 1/4	1 7/8"	3/8"	.135	5/8"	50	500	1.5
11932	981-1 1/2	2 1/8"	3/8"	.148	3/4"	50	500	1.9

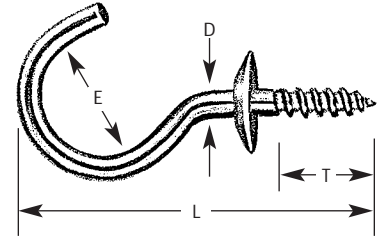

SHOULDER HOOKS IN SOLID BRASS

Numbers		Dimensions						
Model No.	Solid Brass Number	O.A. Length (L)	Thread Length (T)	Wire Diameter (D)	Hook Length (C)	Pcs. Per Shelf Box	Pcs. Per Case	Lbs. Per 100 Pcs.
11958	9412-1/2	1 3/16"	3/16"	.072	5/16"	100	1000	0.19
11960	9412-3/4	1 1/8"	1/4"	.091	7/16"	100	1000	0.38
11961	9412-1	1 9/16"	3/8"	.120	1/2"	100	1000	0.75
11962	9412-1 1/4	1 13/16"	3/8"	.135	1/2"	50	500	1.1
11963	9412-1 1/2	2 1/8"	3/8"	.148	9/16"	50	500	1.5

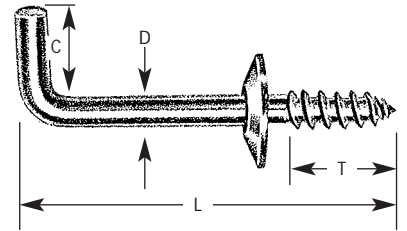

STORM WINDOW EYES Zinc Chromate finish

Numbers		Dimensions							
Model No.	Zinc Chromate No.	Overall Length (L)	Height of Hook	Shank Length (S)	Thread Length (T)	Wire Diameter (D)	Pcs. Per Shelf Box	Pcs. Per Case	Lbs. Per 100 Pcs.
12384	502-1/4"	3 1/8"	-	2 1/4"	1 1/4"	.214	100	1000	4.3
12358	402-1/4"	-	1 1/8"	2 1/4"	1 1/4"	.214	100	1000	4.4

Eye type assembled with 1/16" thick x 9/16" O.D. steel washer.

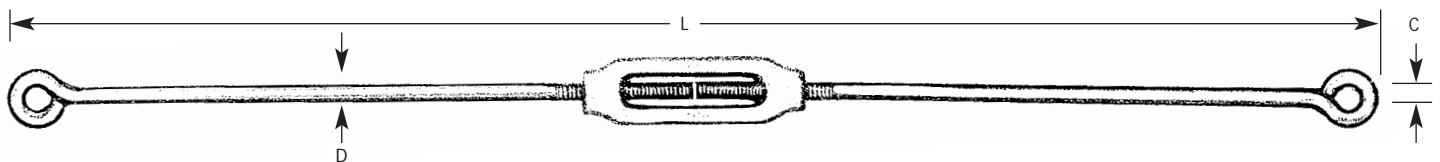
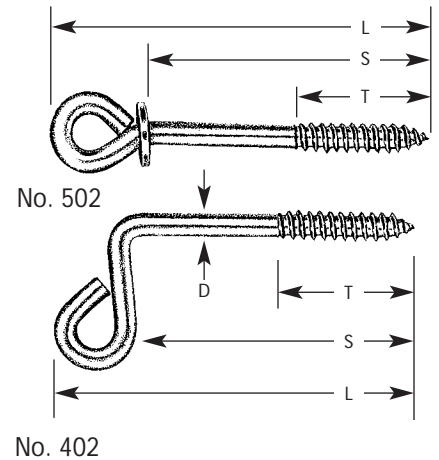

SCREEN DOOR BRACE Zinc Chromate finish

Numbers		Dimensions										
Model No.	Zinc Chromate No.	Thread Diameter	Thread Length	O.A. Closed (L)	O.A. Open	Take Up	Body O.A. Length	I.D. Eye (C)	Wire Diameter (D)	Pcs. Per Shelf Box	Pcs. Per Case	Lbs. Per 100 Pcs.
17347	42	5/32"	1 1/8"	40 1/2"	42"	1 1/2"	1 7/8"	7/32"	.141	10	100	23

Screw Eyes

OPEN STYLE
EXTRA LONG STYLE
STANDARD STYLE

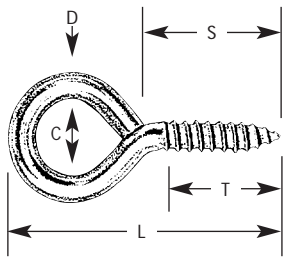

OPEN STYLE Zinc Chromate finish

Numbers		Dimensions								
Model No.	Zinc Chromate No.	Opening	O.A. Length (L)	Shank Length (S)	Thread Length (T)	I. D. Eye (C)	Wire Diameter (D)	Pcs. Per Shelf Box	Pcs. Per Case	Lbs. Per 100 Pcs.
10193	W8 Open	1/4"	1 5/8"	13/16"	5/8"	1/2"	.160	100	1000	1.5
10195	W10 Open	3/16"	1 3/8"	11/16"	5/8"	7/16"	.135	100	1000	1.0

EXTRA LONG STYLE Zinc Chromate finish

Numbers		Dimensions								
Model No.	Zinc Chromate No.	O.A. Length (L)	Shank Length (S)	Thread Length (T)	I. D. Eye (C)	Wire Diameter (D)	Pcs. Per Shelf Box	Pcs. Per Case	Lbs. Per 100 Pcs.	
10012	W8 1/2	2 5/16"	13/8"	13/16"	1/2"	.160	100	1000	2.3	

STANDARD STYLE Available in Zinc Chromate or Solid Brass.

Numbers				Dimensions							
Model No.	Zinc Chromate No.	Model No.	Solid Brass No.	O.A. Length (L)	Shank Length (S)	Thread Length (T)	I. D. Eye (C)	Wire Diameter (D)	Pcs. Per Shelf Box	Pcs. Per Case	Lbs. Per 100 Pcs.
10001	W000			3 7/8"	2 "	1 3/4"	1 1/8"	.365	10	100	22.0
10002	W00			3 7/16"	1 5/8"	1 1/2"	1 "	.331	10	100	13.7
10003	W0			2 7/8"	1 1/2 "	1 5/16"	13/16"	.307	50	500	10.2
10005	W2			2 5/8"	1 1/4"	1 1/8"	3/4"	.264	50	500	6.7
10007	W4	10304	1004	2 3/16"	1 1/8"	1 "	5/8"	.225	50	500	4.3
10009	W6	10305	1006	1 15/16"	15/16"	7/8"	9/16"	.192	100	1000	2.7
10011	W8	10306	1008	1 5/8"	3/4"	5/8"	1/2"	.160	100	1000	1.6
10013	W9			1 9/16"	3/4"	9/16"	7/16"	.148	100	1000	1.3
10014	W10	10308	1010	1 3/8"	11/16"	5/8"	7/16"	.135	100	1000	1.0
10016	W12	10309	1012	1 3/16"	9/16"	1/2"	3/8"	.105	100	1000	0.53
10018	W14	10311	1014	1 1/16"	1/2"	3/8"	5/16"	.080	100	1000	0.28
10042	W104			2 1/16"	1 1/16 "	1 "	1/2"	.225	100	1000	3.8
10044	W106			1 13/16"	15/16"	3/4"	7/16"	.192	100	1000	2.4
10046	W108			1 9/16"	3/4"	5/8"	3/8"	.160	100	1000	1.4
10048	W110			1 5/16"	11/16"	5/8"	5/16"	.135	100	1000	0.75
10050	W112			1 1/8"	9/16"	1/2"	5/16"	.105	100	1000	0.47
10052	W114			15/16"	1/2"	3/8"	1/4"	.080	100	1000	0.22
10078	W204	10370	1204	1 15/16"	1 1/8"	7/8"	5/16"	.225	100	1000	3.2
10080	W206	10372	1206	1 5/8"	15/16"	3/4"	5/16"	.192	100	1000	1.9
10082	W208	10374	1208	1 3/8"	13/16"	5/8"	1/4"	.160	100	1000	1.1
10084	W210	10376	1210	1 3/16"	11/16"	5/8"	1/4"	.135	100	1000	0.69
10085	W211	10376	1210	1 1/16"	5/8"	1/2 "	3/16"	.105	100	1000	0.69
10086	W212	10378	1212	15/16"	1/2"	7/16"	3/16"	.105	100	1000	0.36
10088	W214	10380	1214	13/16"	7/16"	3/8"	3/16"	.080	100	1000	0.19
10090	W216	10382	1216	11/16"	7/16"	3/8"	1/8"	.062	100	1000	0.08
10148	W208 1/2			1 1/8"	1/2"	1/2"	1/4"	.160	100	1000	1.14
10150	W210 1/2			1 "	7/16"	3/8"	1/4"	.135	100	1000	0.63
10151	W211 1/2			7/8"	3/8"	7/16"	3/16"	.120	100	1000	0.47
10152	W212 1/2			3/4"	3/8 "	5/16"	3/16"	.105	100	1000	0.33
10153	W213 1/2			3/4"	5/16"	1/4"	3/16"	.092	100	1000	0.20
10154	W214 1/2	10442	1214 1/2	5/8"	5/16"	1/4"	3/16"	.080	100	1000	0.14
10155	W215 1/2			9/16"	5/16"	1/4"	1/8"	.072	100	1000	0.11
10156	W216 1/2	10444	1216 1/2	1/2"	1/4"	3/16"	1/8"	.062	100	1000	0.09
10157	W217 1/2			9/16"	5/16"	3/16"	1/8"	.056	100	1000	0.06

ROUND BEND SCREW HOOKS
 SQUARE BEND SCREW HOOKS
 CURTAIN ROD HOOKS
 PARALLEL HOOKS

Hooks

ROUND END SCREW HOOKS Available in Zinc Chromate or Solid Brass.

Numbers			Dimensions							
Model No.	Zinc Chromate No.	Model No.	Solid Brass No.	O.A. Length (L)	Thread Length (T)	Hook Opening (E)	Wire Diameter (D)	Pcs. Per Shelf Box	Pcs. Per Case	Lbs. Per 100 Pcs.
10470	W800			4 15/16"	1 3/4"	1"	.307	50	500	15.0
10472	W802			4 7/16"	1 1/2"	1"	.264	50	500	10.0
10473	W803			4 1/8"	1 3/4"	1 5/16"	.244	50	500	8.1
10474	W804			3 7/8"	1 1/2"	1 3/16"	.225	50	500	6.3
10476	W806	10537	1806H	3 3/8"	7/8"	3/4"	.192	100	1000	4.1
10478	W808	10538	1808H	2 9/16"	7/8"	9/16"	.160	100	1000	2.1
10480	W810	10539	1810H	2 1/16"	1 1/16"	3/8"	.135	100	1000	1.2
10482	W812	10540	1812H	1 11/16"	5/8"	5/16"	.105	100	1000	0.5
10484	W814	10541	1814H	1 5/16"	1/2"	1/4"	.080	100	1000	0.28

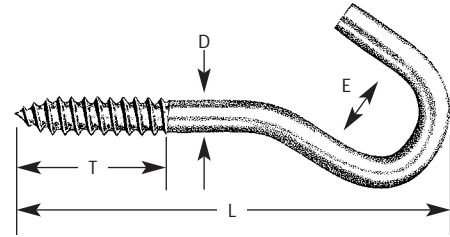

SQUARE BEND SCREW HOOKS Available in Zinc Chromate or Solid Brass.

Numbers			Dimensions							
Model No.	Zinc Chromate No.	Model No.	Solid Brass No.	O.A. Length (L)	Thread Length (T)	Hook Length (C)	Wire Diameter (D)	Pcs. Per Shelf Box	Pcs. Per Case	Lbs. Per 100 Pcs.
10501	W904			3 1/16"	1 3/8"	3/4"	.225	100	1000	4.1
10503	W906	10567	1906	2 5/8"	1"	1 1/16"	.192	100	1000	2.8
10505	W908	10568	1908	2 1/4"	7/8"	5/8"	.160	100	1000	1.6
10507	W910	10569	1910	1 13/16"	1 1/16"	9/16"	.135	100	1000	1.0
10509	W912	10570	1912	1 3/8"	5/8"	3/8"	.105	100	1000	0.44
10511	W914	10571	1914	1"	7/16"	5/16"	.080	100	1000	0.19

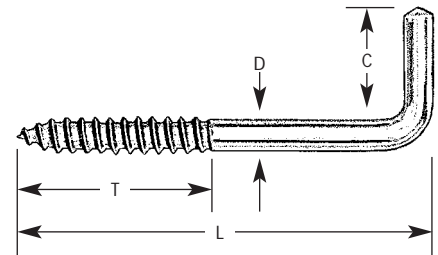

CURTAIN ROD HOOKS Brass finish

Numbers			Dimensions							
Model No.	Brass Plated No.	O.A. Length (L)	Thread Length (T)	Hook Length (C)	Wire Diameter (D)	Pcs. Per Shelf Box	Pcs. Per Case	Lbs. Per 100 Pcs.		
12244	713	1 1/4"	7/16"	3/8"	.092	100	1000	0.31		
12243	711	2 1/4"	1/2"	5/8"	.120	100	1000	1.4		
12247	2710	3"	5/8"	3/4"	.135	100	1000	1.6		
12249	4710	4 1/4"	9/16"	3/4"	.148	100	1000	2.9		
12278	6710	5 3/4"	5/8"	3/4"	.160	100	1000	3.8		

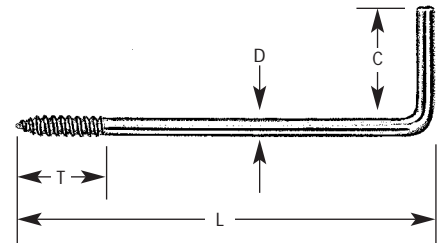

PARALLEL HOOKS Zinc Chromate finish

Numbers			Dimensions							
Model No.	Zinc Chromate No.	O.A. Length (L)	Thread Length (T)	I.D. Hook (C)	Wire Diameter (D)	Pcs. Per Shelf Box	Pcs. Per Case	Lbs. Per 100 Pcs.		
10460	706-2 1/2	2 1/2"	15/16"	15/32"	.192	100	1000	3.4		
10462	706-3	3"	1 1/8"	15/32"	.192	100	1000	3.8		
10464	706-3 1/2	3 1/2"	1 1/4"	15/32"	.192	100	1000	4.4		

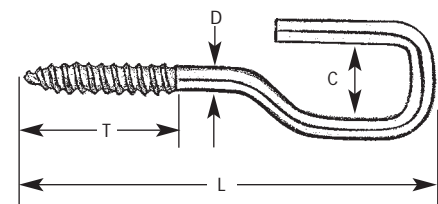

Hooks

S - HOOKS

HEAVY OPEN STYLE S-HOOKS Zinc Chromate finish

Numbers

Dimensions

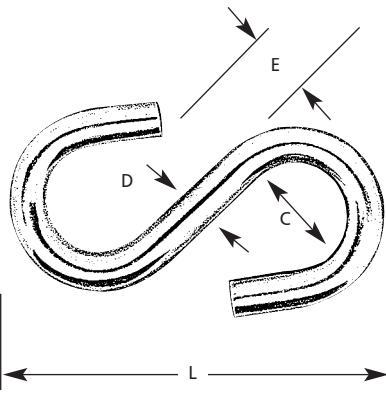

Model No.	Zinc Chromate No.	O.A. Length (L)	Dia. Eye (C)	Opening (E)	Wire Diameter (D)	Pcs. Per Shelf Box	Pcs. Per Case	Lbs. Per 100 Pcs.
11715	174-3/4"	3/4"	3/16"	3/16"	.092	100	1000	0.83
11716	174-1	1"	1/4"	3/16"	.120	100	1000	0.75
11717	174-1 1/4"	1 1/4"	3/8"	1/4"	.148	50	500	1.5
11718	174-1 1/2"	1 1/2"	7/16"	1/4"	.177	50	500	2.4
11719	174-1 3/4"	1 3/4"	1/2"	5/16"	.192	50	500	3.4
11720	174-2	2"	9/16"	3/8"	.250	50	500	5.7
11721	174-2 1/4"	2 1/4"	5/8"	5/16"	.250	50	500	6.9
11722	174-2 1/2"	2 1/2"	3/4"	7/16"	.307	50	500	11.8
11723	174-3	3"	7/8"	1/2"	.307	10	100	14.2

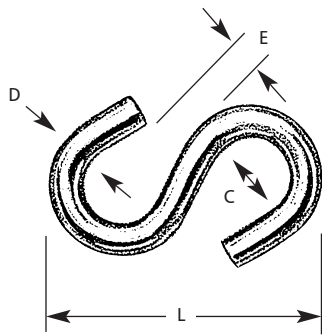

MEDIUM OPEN STYLE S-HOOKS Zinc Chromate finish

Numbers

Dimensions

Model No.	Zinc Chromate No.	O.A. Length (L)	Dia. Eye (C)	Opening (E)	Wire Diameter (D)	Pcs. Per Shelf Box	Pcs. Per Case	Lbs. Per 100 Pcs.
11760	41S	1 1/2"	1/2"	1/4"	.141	20	200	1.7
11761	42S	1 7/8"	5/8"	1/4"	.160	20	200	2.6
11762	43S	2 1/8"	3/4"	1/4"	.177	20	200	3.4
11763	44S	2 1/2"	13/16"	5/16"	.214	20	200	5.7
11764	45S	2 3/4"	7/8"	3/8"	.272	20	200	10.2
11765	46S	3 1/4"	1"	1/2"	.331	10	100	16.8

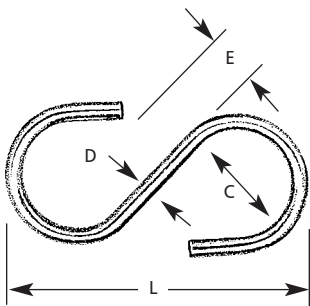

Available in both Zinc Chromate and Solid Brass.

LIGHT OPEN STYLE S-HOOKS

Numbers

Dimensions

Model No.	Zinc Chromate No.	Model No.	Solid Brass Number	O.A. Length (L)	Dia. Eye (C)	Opening (E)	Wire Diameter (D)	Pcs. Per Shelf Box	Pcs. Per Case	Lbs. Per 100 Pcs.
11803	1C	11834	10	1 3/4"	5/8"	5/16"	.105	100	1000	1.1
11804	2C	11835	20	1 1/2"	1/2"	1/4"	.105	100	1000	2.1
11805	3C	11836	30	1 1/4"	3/8"	1/4"	.105	100	1000	0.69
11806	4C	11837	40	1"	5/16"	3/16"	.092	100	1000	0.50
11807	5C	11838	50	7/8"	1/4"	3/16"	.092	100	1000	0.38
11808	6C	11839	60	3/4"	1/4"	1/8"	.080	100	1000	0.25

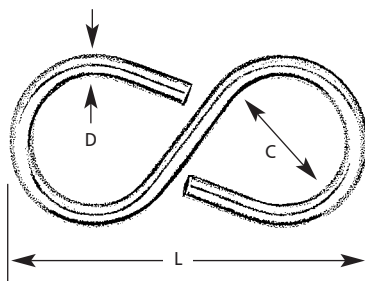

Available in both Zinc Chromate and Solid Brass.

LIGHT CLOSED STYLE S-HOOKS

Numbers

Dimensions

Model No.	Zinc Chromate No.	Model No.	Solid Brass Number	O.A. Length (L)	Dia. Eye (C)	Wire Diameter (D)	Pcs. Per Shelf Box	Pcs. Per Case	Lbs. Per 100 Pcs.
11774	809C			2 1/8"	3/4"	.148	100	1000	2.7
		11865	1809S	2 1/8"	3/4"	.141	100	1000	2.9
11775	810C	11866	1810S	1 5/8"	1/2"	.135	100	1000	1.7
11776	811C	11867	1811S	1 1/4"	3/8"	.120	100	1000	1.0
11777	812C	11868	1812S	1 1/8"	5/16"	.105	100	1000	0.69
11778	813C			7/8"	1/4"	.092	100	1000	0.38

Hooks

GATE HOOKS Solid Brass finish.

Numbers		Dimensions					
Model No.	Solid Brass Number	Hook Length (L)	Wire Diameter	Screw Eye Number	Pcs. Per Shelf Box	Pcs. Per Case	Lbs. Per 100 Pcs.
10639	1040-1½	1½"	.135	1210	100	1000	2.4
10640	1040-2	2"	.141	1210	50	500	3.4
10641	1040-2½	2½"	.160	1208	50	500	4.7
10642	1040-3	3"	.186	1208	50	500	5.8

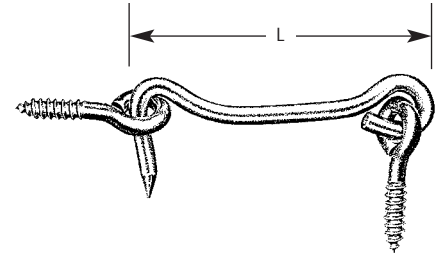

GATE HOOKS Zinc Chromate finish.

Numbers		Dimensions					
Model No.	Zinc Chromate Number	Hook Length (L)	Wire Diameter	Screw Eye Number	Pcs. Per Shelf Box	Pcs. Per Case	Lbs. Per 100 Pcs.
10600	W40-1	1"	.105	213	100	1000	0.7
10601	W40-1½	1½"	.135	211	100	1000	2.1
10602	W40-2	2"	.148	210	50	500	3.2
10603	W40-2½	2½"	.160	209	50	500	4.3
10604	W40-3	3"	.177	208	50	500	5.7
10605	W40-4	4"	.192	206	50	500	8.9
10607	W40-6	6"	.225	204	10	100	16.0
10608	W40-8	8"	.225	204	10	100	19.1
10610	W40-12	12"	.225	204	10	100	24.4

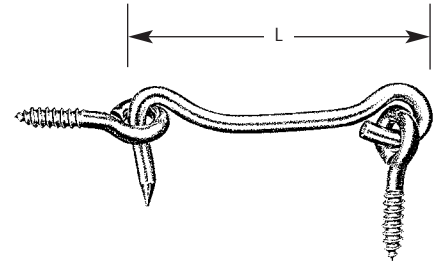

SAFETY GATE HOOKS Zinc Chromate finish.

Numbers		Dimensions					
Model No.	Zinc Chromate Number	Hook Length (L)	Wire Diameter	Screw Eye Number	Pcs. Per Shelf Box	Pcs. Per Case	Lbs. Per 100 Pcs.
10650	W740-2	2"	.148	210	50	500	3.3
10651	W740-2 ½	2½"	.160	209	50	500	4.5
10652	W740-3	3"	.177	208	50	500	5.5

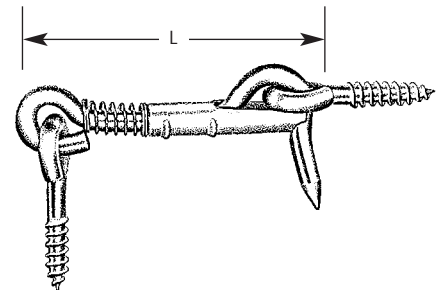

Hooks

SCREW HOOKS
CLOTHESLINE HOOKS
Zinc Chromate finish

SCREW HOOKS Lag Screw Thread

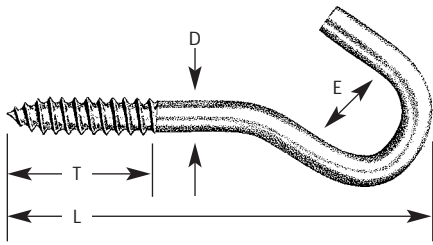

Numbers		Dimensions						
Model No.	Zinc Chromate Number	O.A. Length (L)	Thread Length (T)	Hook Opening (E)	Wire Diameter (D)	Pcs. Per Shelf Box	Pcs. Per Case	Lbs. Per 100 Pcs.
12152	324-1/4	4 1/8"	1 3/4"	1 5/16"	.244	10	100	8.6
12153	324-5/16	4 1/2"	1 3/4"	1"	.307	10	100	13.6
12154	324-3/8	4 7/8"	1 3/4"	1 1/16"	.365	10	100	21.0

SCREW HOOKS Machine Thread with Hex Nut

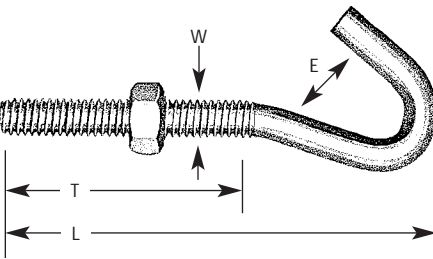

Numbers		Dimensions							
Model No.	Zinc Chromate Number	O.A. Length (L)	Thread Length (T)	Hook Opening (E)	Thread Size (W)	Wire Dia.	Pcs. Per Shelf Box	Pcs. Per Case	Lbs. Per 100 Pcs.
12188	614-5/32	1 5/8"	1"	1/4"	8-32	.141	10	100	1.6
12189	614-3/16	2"	1 1/4"	5/16"	10-24	.160	10	100	2.1
12190	614-7/32	2 3/8"	1 3/8"	3/8"	12-24	.186	10	100	2.6
12191	614-1/4	2 5/8"	1 9/16"	3/8"	1/4-20	.214	10	100	4.3
12192	614-5/16	3 1/4"	1 3/4"	5/8"	5/16-18	.272	10	100	9.1
12193	614-3/8	3 7/8"	2 3/8"	1 1/16"	3/8-16	.331	10	100	14.8

CLOTHESLINE HOOK Lag Screw Thread For Wooden Posts

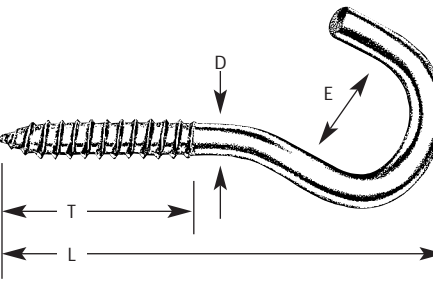

Numbers		Dimensions						
Model No.	Zinc Chromate Number	O.A. Length (L)	Thread Length (T)	Hook Opening (E)	Wire Diameter (D)	Pcs. Per Shelf Box	Pcs. Per Case	Lbs. Per 100 Pcs.
12077	240-5/16	4"	1 3/4"	1 3/16"	.307	10	100	11.4

CLOTHESLINE HOOKS Machine Thread for Metal Posts

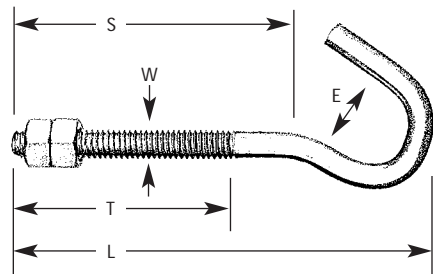

Numbers		Dimensions							
Model No.	Zinc Chromate Number	O.A. Length (L)	Thread Length (T)	Shank Length (S)	Hook Opening (E)	Thread Size (W)	Pcs. Per Shelf Box	Pcs. Per Case	Lbs. Per 100 Pcs.
12130	442	4 1/4"	2 3/4"	2 7/8"	3/4"	1/4-20	10	100	8.0
12050	540	4 1/4"	2 5/16"	2 3/4"	1 5/16"	5/16-18	10	100	12.3
12131	542	6"	3 7/8"	4 1/2"	7/8"	5/16-18	10	100	16.0
12132	622	7 1/4"	3 7/8"	4 7/8"	1 1/16"	3/8-16	10	100	27.0
12133	642	8 1/4"	3 7/8"	5 7/8"	1 1/16"	3/8-16	10	100	29.4

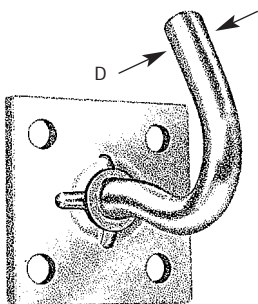

CLOTHESLINE HOOK Plate Style

Numbers		Dimensions					Pcs. Per Shelf Box	Pcs. Per Case	Lbs. Per 100 Pcs.
Model No.	Zinc Chromate Number	Projection Length	Plate Size	Wire Diameter (D)					
12102	340	2"	1 3/4" x 1 3/4"	.307		10	100	16.0	

HAMMOCK HOOKS
 PORCH SWING HOOKS
 HITCHING RINGS
 Zinc Chromate finish

Hooks & Rings

HAMMOCK HOOK Plate Style

Numbers		Dimensions						
Model No.	Zinc Chromate Number	Overall Length (L)	Hook Opening (E)	Plate Size	Wire Diameter	Pcs. Per Shelf Box	Pcs. Per Case	Lbs. Per 100 Pcs.
11540	134	3 7/8"	1"	1 3/4" x 2 1/8"	.307	10		100

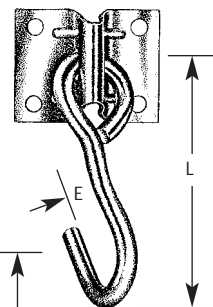

HAMMOCK HOOK Lag Thread Style

Numbers		Dimensions								
Model No.	Zinc Chromate Number	Overall Length (L)	Eye Length	Thread Length	Hook Opening (E)	Hook Wire Diameter	Eye Wire Diameter	Pcs. Per Shelf Box	Pcs. Per Case	Lbs. Per 100 Pcs.
11515	124	3 5/8"	3 1/4"	1 3/4"	1"	.365	.365	10	100	25.8

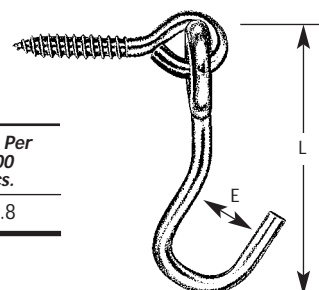

PORCH SWING HOOKS

Numbers		Dimensions						
Model No.	Zinc Chromate Number	O.A. Length (L)	Thread Length (T)	Hook Opening (E)	Wire Diameter (D)	Pcs. Per Shelf Box	Pcs. Per Case	Lbs. Per 100 Pcs.
11689	234	3 5/8"	1 3/4"	3/4"	.307	10	100	10.9
11690	254	4 1/4"	1 3/4"	3/4"	.365	10	100	16.0

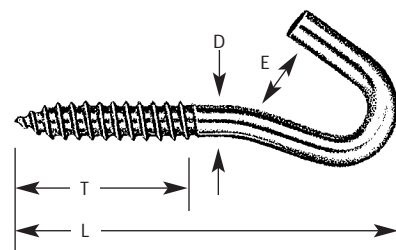

HITCHING RING Plate Style

Numbers		Dimensions				
Model No.	Zinc Chromate Number	Plate Size	Ring Size (C)	Pcs. Per Shelf Box	Pcs. Per Case	Lbs. Per 100 Pcs.
11640	24H	1 3/4" x 2 1/8"	.307 x 2" I.D.	10	100	28.1

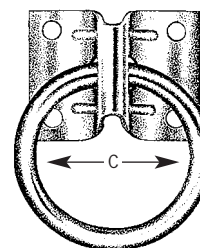

HITCHING RINGS Machine Thread Style with Hex Nut

Numbers		Dimensions							
Model No.	Zinc Chromate Number	Shank Length (S)	Ring Size (C)	Thread Length (T)	Thread Size	Wire Diameter (D)	Pcs. Per Shelf Box	Pcs. Per Case	Lbs. Per 100 Pcs.
11661	34-2 1/2	2 1/2"	.307 x 2" I.D.	2"	3/8-16	.331	10	100	31.0
11662	34-4	4"	.307 x 2" I.D.	3"	3/8-16	.331	10	100	35.4
11663	34-6	6"	.307 x 2" I.D.	4"	3/8-16	.331	10	100	40.0

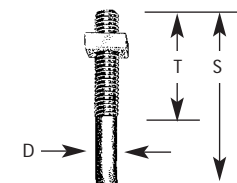

HITCHING RING Lag Thread Style

Numbers		Dimensions							
Model No.	Zinc Chromate Number	Eye O.A. Length (L)	Shank Length (S)	Thread Length (T)	Ring Size (C)	Wire Diameter (D)	Pcs. Per Shelf Box	Pcs. Per Case	Lbs. Per 100 Pcs.
11615	14H	3 5/8"	2"	1 15/16"	.307 x 2"	.365	10	100	31.0

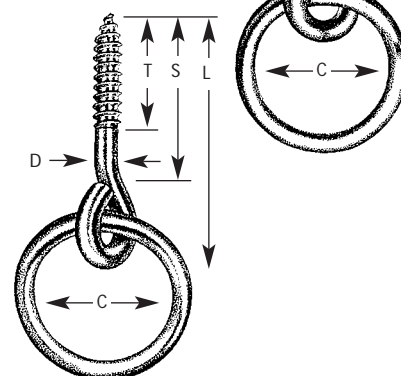

Stor-All Hooks

Plastisol Coated
Zinc Chromate Finish

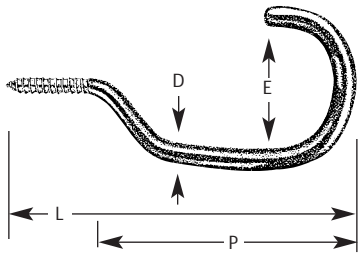

STOR-ALL OVERHEAD HOOKS

Plastisol coated – designed primarily for overhead use.

Numbers			Dimensions						
Model No.	Product Number	Finish	O.A. Length (L)	Projection Length (P)	Hook Opening (E)	Wire Diameter (D)	Pcs. Per Shelf Box	Pcs. Per Case	Lbs. Per 100 Pcs.
12440	101P	Plastisol Coated	6"	4 1/2"	2 1/16"	.264	10	100	19.0
12541	121P	Plastisol Coated	5"	3 7/8"	1 13/16"	.225	20	200	11.7

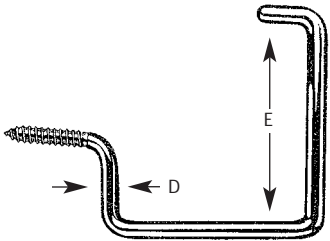

STOR-ALL UTILITY HOOK

Plastisol coated – designed for both vertical and overhead use.

Numbers			Dimensions					
Model No.	Product Number	Finish	Inside Width (E)	Inside Length (E)	Wire Diameter (D)	Pcs. Per Shelf Box	Pcs. Per Case	Lbs. Per 100 Pcs.
12442	103P	Plastisol Coated	3 1/2"	3 1/2"	.264	10	100	23.4

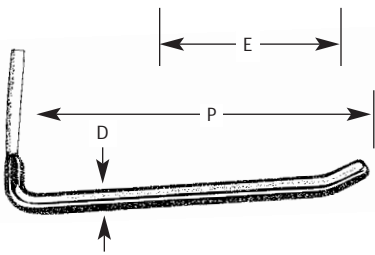

STOR-ALL LADDER HOOKS

Designed to be mounted with 2 screws on vertical surfaces.

Numbers			Dimensions					
Model No.	Product Number	Finish	Projection Length (P)	Wire Diameter (D)	Pcs. Per Shelf Box	Pcs. Per Case	Lbs. Per 100 Pcs.	
12443	102P	Plastisol Coated	6"	.264	10	100	18.4	

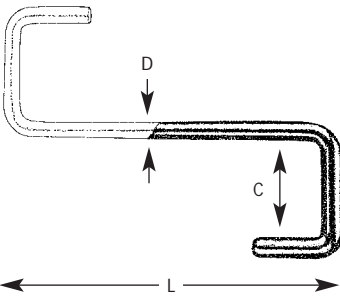

STOR-ALL RAFTER HOOKS

Designed to hang from a standard 2 x 4.

Numbers			Dimensions					
Model No.	Product Number	Finish	O.A. Length (L)	Inside Width (C)	Wire Diameter (D)	Pcs. Per Shelf Box	Pcs. Per Case	Lbs. Per 100 Pcs.
12492	105	Zinc Chromate	6"	1 5/8"	.264	10	100	18.0
12462	105P	Plastisol Coated	6"	1 5/8"	.264	10	100	18.9

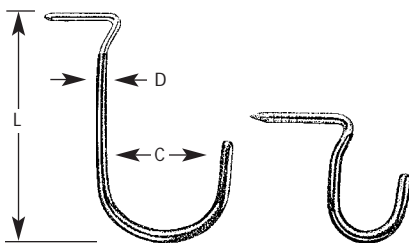

STOR-ALL DRIVE HOOKS

Designed to be hammered into any supporting surface.

Numbers			Dimensions					
Model No.	Product Number	Finish	O.A. Length (L)	Hook Opening (C)	Wire Diameter (D)	Pcs. Per Shelf Box	Pcs. Per Case	Lbs. Per 100 Pcs.
12994	107	Zinc Chromate	2 3/8"	1 1/4"	.192	50	500	4.5
12995	107P	Plastisol Coated	2 3/8"	1 1/4"	.192	50	500	5.0
12496	109	Zinc Chromate	5 3/16"	2 3/4"	.192	20	200	9.0
12497	109P	Plastisol Coated	5 3/16"	2 3/4"	.192	20	200	9.9

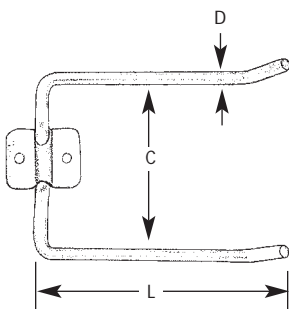

STOR-ALL 2-PRONG TOOL HOOK

Designed to be mounted with 2 screws and plate.

Numbers			Dimensions					
Model No.	Product Number	Finish	Inside Width (C)	Projection Length (P)	Wire Diameter (D)	Pcs. Per Shelf Box	Pcs. Per Case	Lbs. Per 100 Pcs.
12498	111	Zinc Chromate	3 1/4"	4"	.225	10	100	18.5

Plastisol Coated
Zinc Chromate Finish

Stor-All Hooks

STOR-ALL TOOL CLIPS AND BROOM CLIPS

Designed to be mounted with one screw.

Numbers

Dimensions

Model No.	Product Number	Description	Finish	For Diameter Size	Pcs. Per Shelf Box	Pcs. Per Case	Lbs. Per 100 Pcs.
12533	113	Tool Clip	Zinc Chromate	3/8" - 5/8"	50	500	1.7
12535	115	Broom Clip	Zinc Chromate	3/4" - 1 1/8"	50	500	4.0

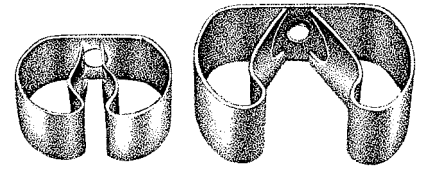

No. 113

No. 115

STOR-ALL Y HOOK

A multi-purpose storage hook designed for vertical use.
Heavy red plastisol coating; packed 10 pcs. per shelf box.

Numbers

Dimensions

Model No.	Product Number	Finish	Inside Width (C)	Projection Length (P)	Wire Diameter (D)	Lbs. Per 100 Pcs.
12536	117P	Plastisol Coated	1 5/8"	2 7/8"	.264	14.5

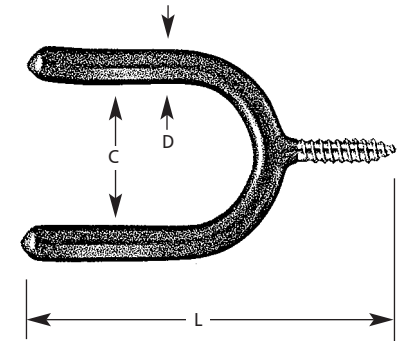

STOR-ALL UTILITY HOOK

A multi-purpose storage hook designed for vertical use.
Heavy red plastisol coating; packed 10 pcs. per shelf box.

Numbers

Dimensions

Model No.	Product Number	Finish	O.A. Length (L)	Projection Length (P)	Wire Diameter (D)	Lbs. Per 100 Pcs.
12539	119P	Plastisol Coated	8"	6 1/4"	.264	22.7

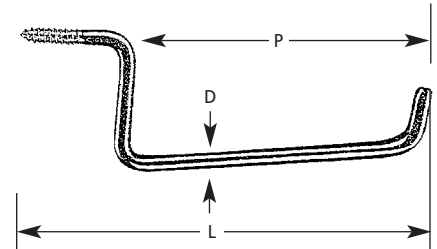

STOR-ALL SCREW HOOK

Numbers

Dimensions

Model No.	Product Number	Finish	O.A. Length (L)	Projection Length (P)	Hook Opening (C)	Wire Diameter (D)	Pcs. Per Shelf Box	Pcs. Per Case	Lbs. Per 100 Pcs.
12537	806P	Plastisol Coated	3 3/8"	2 1/8"	3/4"	.192	50	500	4.7

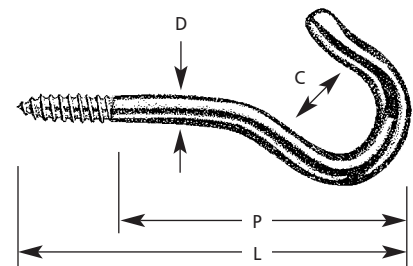

STOR-ALL COAT AND HAT HOOKS

Numbers

Dimensions

Model No.	Product Number	Finish	Projection Length (P)	Height (H)	Wire Diameter (D)	Pcs. Per Shelf Box	Pcs. Per Case	Lbs. Per 100 Pcs.
12299	B446	Brass Plated	3 1/8"	1 3/4"	.135	50	500	6.2
12301	N446	Nickel Plated	3 1/8"	1 3/4"	.135	50	500	6.2
12302	W446P	Plastisol Coated	3 1/8"	1 3/4"	.135	50	500	7.1
12303	Z446	Zinc Chromate	3 1/8"	1 3/4"	.135	50	500	6.2

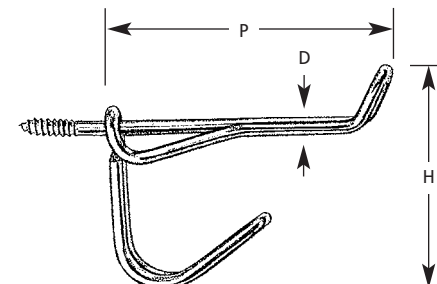

Peg Hooks

REGULAR DUTY

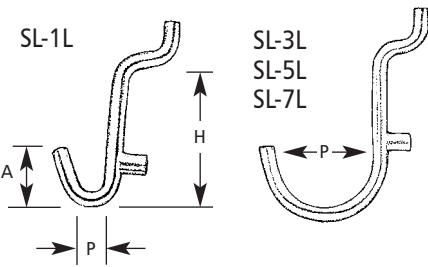

(SL-11L not pictured)

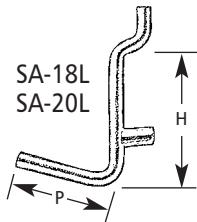

SINGLE LOOP HOOKS

Fit 1/8" and 1/4" perforated board. Zinc Chromate finish.

Numbers		Dimensions						
Model No.	Item Number	Projection Length (P)	Height (H)	Hook Length (A)	Wire Diameter	Pcs. Per Shelf Box	Pcs. Per Case	Lbs. Per 100 Pcs.
13501	SL-11L	1/4"	7/8"	5/8"	.148	100	1000	1.2
13502	SL-1L	1/4"	1 1/2"	5/8"	.148	100	1000	1.7
13503	SL-3L	1/2"	1 1/2"	5/8"	.148	100	1000	1.8
13504	SL-5L	1"	1 1/2"	3/4"	.148	100	1000	2.2
13505	SL-7L	1 1/2"	1 3/4"	1"	.148	100	1000	2.6

STRAIGHT ARM HOOKS

Fit 1/8" and 1/4" perforated board. Zinc Chromate finish.

Numbers		Dimensions						
Model No.	Item Number	Projection Length (P)	Height (H)	Wire Diameter	Pcs. Per Shelf Box	Pcs. Per Case	Lbs. Per 100 Pcs.	
13510	SA-18L	7/8"	1 1/2"	.148	100	1000	1.8	
13511	SA-20L	1 1/2"	1 1/2"	.148	100	1000	2.2	

DB-2L DB-8L
DB-4L DB-10L
DB-6L

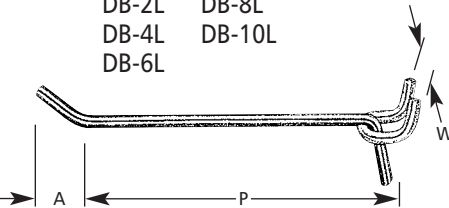

DOUBLE BACK SINGLE HOOKS

Fit 1/8" and 1/4" perforated board. Zinc Chromate finish.

Numbers		Dimensions						
Model No.	Item Number	Projection Length (P)	Width (H)	Hook Length (A)	Wire Diameter	Pcs. Per Shelf Box	Pcs. Per Case	Lbs. Per 100 Pcs.
13515	DB-2L	2"	1"	1/2"	.148	20	200	3.8
13516	DB-4L	4"	1"	1/2"	.148	20	200	5.1
13517	DB-6L	6"	1"	1/2"	.148	20	200	6.3
13518	DB-8L	8"	1"	1/2"	.148	20	200	6.9
13519	DB-10L	10"	1"	1/2"	.148	20	200	8.2

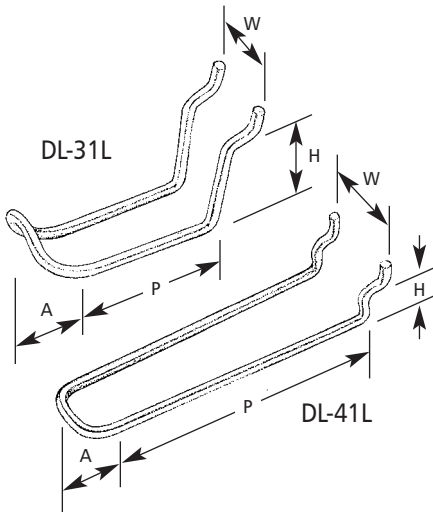

DOUBLE LOOP HOOKS

Fit 1/8" and 1/4" perforated board. Zinc Chromate finish.

Numbers		Dimensions							
Model No.	Item Number	Projection Length (P)	Height (H)	Width (W)	Hook Length (A)	Wire Diameter	Pcs. Per Shelf Box	Pcs. Per Case	Lbs. Per 100 Pcs.
13525	DL-31L	3"	1 3/4"	1"	1 1/4"	.148	30	300	7.2
13526	DL-41L	4 1/2"	1 1/4"	1"	1/2"	.148	40	400	7.9

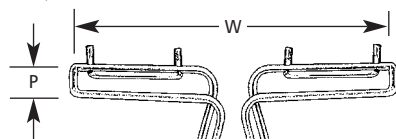

LH-2L
LH-3L

LITERATURE HOLDERS

Fit 1/8" and 1/4" perforated board. Zinc Chromate finish.

Numbers		Dimensions						
Model No.	Item Number	Projection Length (P)	Height (H)	Width (W)	Wire Diameter	Pcs. Per Shelf Box	Pcs. Per Case	Lbs. Per 100 Pcs.
13613	LH-2L	1 3/4"	5"	4 3/4"	.148	10	100	22.0
13615	LH-3L	1 3/4"	7 1/8"	6 5/8"	.148	10	100	30.0

Peg Hooks

REGULAR DUTY

DOUBLE ARM HOOKS

Fit 1/8" and 1/4" perforated board. Zinc Chromate finish.

Numbers		Dimensions							
Model No.	Item Number	Projection Length (P)	Width (W)	Inside Width (C)	Hook Length (A)	Wire Diameter	Pcs. Per Shelf Box	Pcs. Per Case	Lbs. Per 100 Pcs.
13530	DA-22L	2"	2"	1 1/2"	1/2"	.148	40	400	5.7
13531	DA-24L	4"	2"	1 1/2"	1/2"	.148	20	200	8.2
13532	DA-26L	6"	2"	1 1/2"	1/2"	.148	20	200	10.7

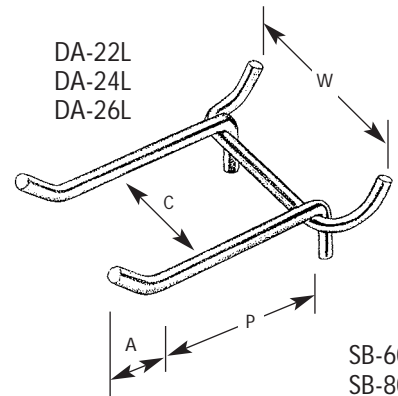

SHELF BRACKETS

Fit 1/8" and 1/4" perforated board. Zinc Chromate finish.

Numbers		Dimensions						
Model No.	Item Number	Projection Length (P)	Height (H)	Width (W)	Wire Diameter	Pcs. Per Shelf Box	Pcs. Per Case	Lbs. Per 100 Pcs.
13541	SB-60L	6"	2 1/4"	1"	.148	30	300	6.7
13542	SB-80L	8"	2 1/4"	1"	.148	20	200	8.8
13543	SB-100L	10"	3 1/2"	1"	.148	10	100	10.7

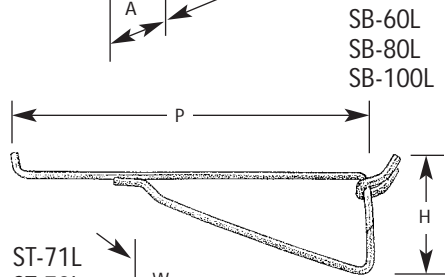

SINGLE TOOL HOLDERS

Fit 1/8" and 1/4" perforated board. Zinc Chromate finish.

Numbers		Dimensions							
Model No.	Item Number	Projection Length (P)	Height (H)	Width (W)	Inside Diameter (C)	Wire Diameter	Pcs. Per Shelf Box	Pcs. Per Case	Lbs. Per 100 Pcs.
13550	ST-71L	1"	1 1/2"	1"	1/2"	.148	30	300	2.8
13551	ST-72L	1 3/4"	1 3/4"	1"	3/4"	.148	30	300	4.6
13552	ST-73L	1 1/2"	1"	1"			20	200	3.8
13553	ST-74L	1 1/4"	3/4"		1 1/2"	.123	50	500	2.6

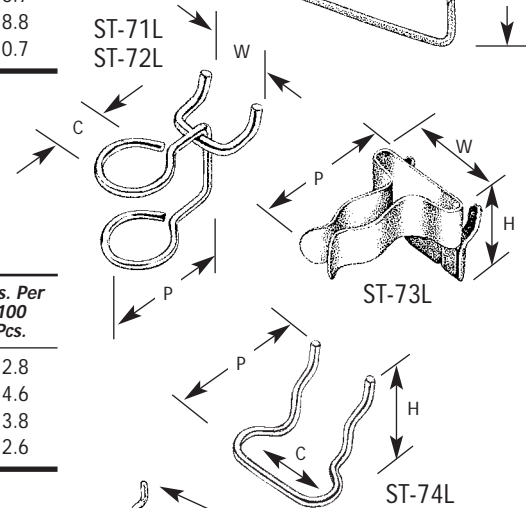

MULTIPLE TOOL HOLDERS

Fit 1/8" and 1/4" perforated board. Zinc Chromate finish.

Numbers		Dimensions							
Model No.	Item Number	Projection Length (P)	Height (H)	Width (W)	Inside Diameter (C)	Wire Diameter	Pcs. Per Shelf Box	Pcs. Per Case	Lbs. Per 100 Pcs.
13558	MT-75L	1 3/4"	1 3/4"	9"	3/4"	.148	10		26.3
13559	MT-76L	1"	1"	9"	3/8"	.148	10		13.8

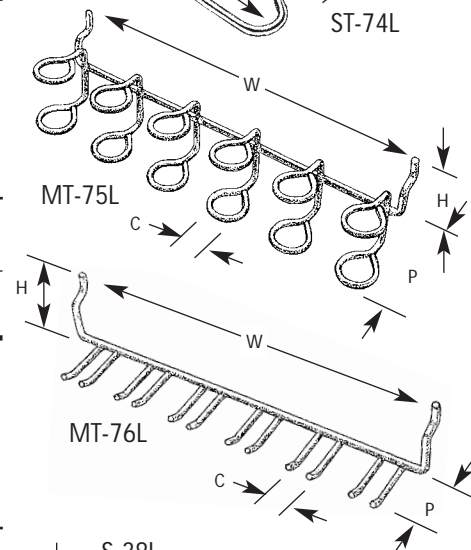

SPACERS AND SCREWS

Fit 1/8" and 1/4" perforated board. Zinc Chromate finish.

Numbers		Dimensions				
Model No.	Item Number	Length (L)	Width (W)	Pcs. Per Shelf Box	Pcs. Per Case	Lbs. Per 100 Pcs.
13565	S-38L	1/2"	3/8"	100	1000	.4
13567	S-39L	1 1/4"		100	1000	.8

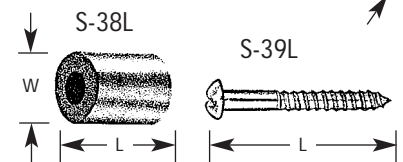

Peg Hooks

HEAVY DUTY

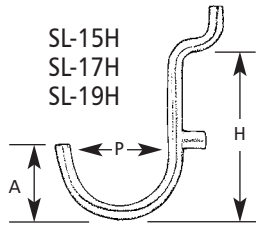

SINGLE LOOP HOOKS

Fit 1/4" perforated board only. Zinc Chromate finish.

Numbers		Dimensions						
Model No.	Item Number	Projection Length (P)	Height (H)	Hook Length (A)	Wire Diameter	Pcs. Per Shelf Box	Pcs. Per Case	Lbs. Per 100 Pcs.
13570	SL-15H	5/8"	1 1/4"	7/8"	.205	50	500	4.3
13571	SL-17H	1 1/2"	1 3/4"	1"	.205	20	200	5.7
13572	SL-19H	2"	2"	1 1/4"	.205	20	200	8.6

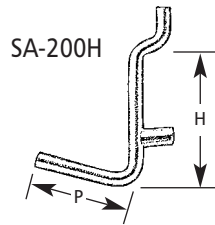

STRAIGHT ARM HOOK

Fits 1/4" perforated board only. Zinc Chromate finish.

Numbers		Dimensions						
Model No.	Item Number	Projection Length (P)	Height (H)	Wire Diameter	Pcs. Per Shelf Box	Pcs. Per Case	Lbs. Per 100 Pcs.	
13577	SA-200H	1 1/2"	1 1/2"	.205	50	500	4.3	

DB-33H
DB-55H
DB-88H
DB-111H

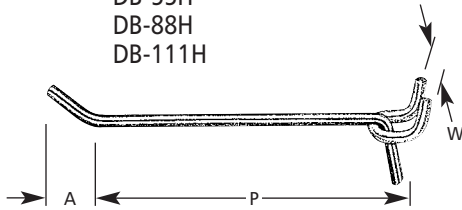

DOUBLE BACK SINGLE HOOKS

Fit 1/4" perforated board only. Zinc Chromate finish.

Numbers		Dimensions						
Model No.	Item Number	Projection Length (P)	Width (W)	Hook Length (A)	Wire Diameter	Pcs. Per Shelf Box	Pcs. Per Case	Lbs. Per 100 Pcs.
13580	DB-33H	3"	1"	3/4"	.223	20	200	9.4
13581	DB-55H	5"	1"	3/4"	.223	20	200	11.3
13582	DB-88H	8"	1"	3/4"	.223	10	100	16.1
13583	DB-111H	11"	1"	3/4"	.223	10	100	21.3

DA-23H
DA-25H
DA-28H

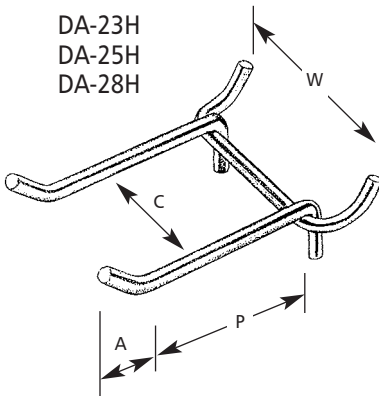

DOUBLE ARM HOOKS

Fit 1/4" perforated board only. Zinc Chromate finish.

Numbers		Dimensions							
Model No.	Item Number	Projection Length (P)	Width (W)	Inside Width (C)	Hook Length (A)	Wire Diameter	Pcs. Per Shelf Box	Pcs. Per Case	Lbs. Per 100 Pcs.
13587	DA-23H	3"	2"	1 1/2"	3/4"	.223	10	100	16.3
13588	DA-25H	5"	2"	1 1/2"	3/4"	.223	10	100	21.3
13589	DA-28H	8"	2"	1 1/2"	3/4"	.223	10	100	30.2

SB-81H SB-121H
SB-101H SB-161H

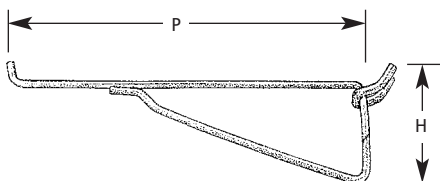

SHELF BRACKETS

Fit 1/4" perforated board only. Zinc Chromate finish.

Numbers		Dimensions						
Model No.	Item Number	Projection Length (P)	Height (H)	Width (W)	Wire Diameter	Pcs. Per Shelf Box	Pcs. Per Case	Lbs. Per 100 Pcs.
13593	SB-81H	8"	2 1/4"	1"	.205	10	100	17.6
13594	SB-101H	10"	2 5/8"	1"	.205	10	100	23.8
13595	SB-121H	12"	3 1/2"	1"	.205	10	100	30.2
13596	SB-161H	16"	3 1/2"	1"	.223	10	100	48.0

COTTER PIN
PEG HOOK
STOR - ALL

Assortments

Hindley offers a wide variety of merchandise assortments for most of its wire hardware. Additional information on all our wire rack, open stock plan-o-gram and carded assortments is available in our current Net Price Book or Merchandise Catalog.

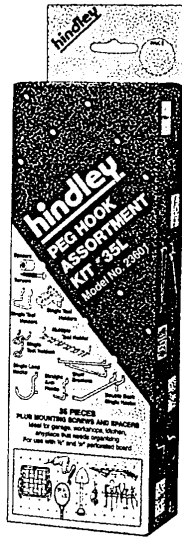

COTTER PIN ASSORTMENTS

Model No.	Product No.	Description	Pins Per Assortment
55000	No. 1	Steel - Heavy Duty	100
55001	No. 3	Zinc Plated Steel - Automotive	100
55002	No. 3B	Solid Brass - Marine Use	100
55003	No. 5	Zinc Plate Steel - General Purpose	100
55004	No. 5B	Solid Brass - General Purpose	100

PEG HOOK ASSORTMENT NO. 20H

Fits 1/4" perforated board. Zinc Chromate finish.

Model No. 23600

Model No.	Product No.	Description	Pieces Per Kit
13570	SL-15H	Single Loop Hook	4
13571	SL-17H	Single Loop Hook	2
13572	SL-19H	Single Loop Hook	2
13577	SA-200H	Straight Arm Hook	6
13581	DB-55H	Double Back Single Hook	2
13587	DA-23H	Double Arm Hook	2
13593	SB-81H	Shelf Bracket	2
13565	S-38L	Spacers	8
13567	S-39L	Screws	8

PEG HOOK ASSORTMENT NO. 35L

Fits 1/8" and 1/4" perforated board. Zinc Chromate finish.

Model No. 23601

Model No.	Product No.	Description	Pieces Per Kit
13502	SL-1L	Single Loop Hook	6
13504	SL-5L	Single Loop Hook	4
13505	SL-7L	Single Loop Hook	4
13510	SA-18L	Straight Arm Hook	6
13511	SA-20L	Straight Arm Hook	4
13515	DB-2L	Double Back Single Hook	2
13541	SB-60L	Shelf Bracket	2
13550	ST-71L	Single Tool Holder	1
13551	ST-72L	Single Tool Holder	1
13552	ST-73L	Single Tool Holder	2
13553	ST-74L	Single Tool Holder	2
13559	MT-76L	Multiple Tool Holder	1
13565	S-38L	Spacers	8
13567	S-39L	Screws	8

Cotter Pins

EXTENDED PRONG HUMP

EXTENDED PRONG COTTER PINS

Hindley is one of the country's oldest and largest producers of Cotter Pins. The cotter pins are available in a wide variety of metals and sizes. These pins are manufactured to meet all military and aeronautical standards including MS24665 (AN380 and AN381), MS 9245 (AMS7211), 69272 (AMS7211).

Steel cotter pins, Brass, Everdur-Silicon Bronze, Monel and Stainless Steel are stocked from 1/32" to 1/2" diameter. Selected sizes are produced from Aluminum (5056), Phosphor Bronze, and Stainless Steel in T316 and T321.

Specific sizes and prices are listed in our current Net Price Book and MS sheets on request.

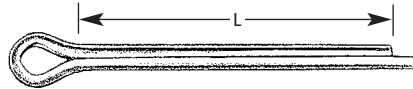

Length of Cotter pin is measured from underneath head to extreme short shank.

HUMP COTTER PINS

We have the capability to manufacture stainless steel cotter pins with a variety of sizes and styles with humps or shoulders. A few of the different sizes are illustrated, the table below lists common sizes. Please call our sales office for assistance with your exact requirement and availability.

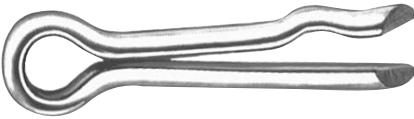

Diameter	Eye to Hump (A)	Shank Length (B)	O.A. Length	Hump Style
1/8 (.120 x .060)	9/16"	9/32"	1.40	Knee
5/32 (.120 x .074)	5/8"	5/8"	1.625	Knee
3/16 (.174 x .067)	11/16"	11/16"	1.875	Knee
1/4 (.250 x .125)	5/64"	1 11/16"	2.125	Shoulder

MS87006 HOOK CHAIN "S"

Numbers

Dimensions

Model No.	Item Number	Inside Reach (R)	Dia. Eye-A (C)	Opening-A (E)	Dia. Eye-B (F)	Opening-B (G)	Wire Diameter	Pkg. Bulk
-----------	-------------	------------------	----------------	---------------	----------------	---------------	---------------	-----------

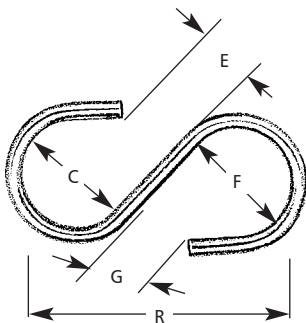

STEEL PLAIN FINISH

03020	MS87006-1	27/32"	9/32"	1/8"	5/16"	3/16"	.080	500 min.
03021	MS87006-11	15/16"	9/32"	11/64"	5/16"	3/16"	.105	500 min.
03022	MS87006-21	1 3/32"	25/64"	3/32"	13/32"	1/8"	.105	500 min.
03023	MS87006-31	1 7/16"	9/32"	9/32"	11/16"	13/32"	.120	500 min.
03024	MS87006-41	1 7/16"	13/32"	5/16"	11/16"	9/16"	.120	500 min.
03025	MS87006-51	1 1/16"	11/32"	3/16"	13/32"	1/4"	.135	500 min.
03026	MS87006-61	1 1/16"	3/8"	1/4"	3/8"	9/32"	.160	500 min.

CADMIUM PLATED STEEL

13020	MS87006-3	27/32"	9/32"	1/8"	5/16"	3/16"	.080	500 min.
13021	MS87006-13	15/16"	9/32"	11/64"	5/16"	3/16"	.105	500 min.
13022	MS87006-23	1 3/32"	25/64"	3/32"	13/32"	1/8"	.105	500 min.
13023	MS87006-33	1 7/16"	9/32"	9/32"	11/16"	13/32"	.120	500 min.
13024	MS87006-43	1 7/16"	13/32"	5/16"	11/16"	9/16"	.120	500 min.
13025	MS87006-53	1 1/16"	11/32"	3/16"	13/32"	1/4"	.135	500 min.
13026	MS87006-63	1 1/16"	3/8"	1/4"	3/8"	9/32"	.160	500 min.

BRASS PLAIN FINISH

13007	MS87006-2	27/32"	9/32"	1/8"	5/16"	3/16"	.080	500 min.
13008	MS87006-12	15/16"	9/32"	11/64"	5/16"	3/16"	.106	500 min.
13009	MS87006-22	1 3/32"	25/64"	3/32"	13/32"	1/8"	.106	500 min.
13010	MS87006-32	1 7/16"	9/32"	9/32"	11/16"	13/32"	.115	500 min.
13011	MS87006-42	1 7/16"	13/32"	5/16"	11/16"	9/16"	.115	500 min.
13012	MS87006-52	1 1/16"	11/32"	3/16"	13/32"	1/4"	.135	500 min.
13014	MS87006-62	1 1/16"	3/8"	1/4"	1/8"	9/32"	.159	500 min.

Special Wire Forms

Hindley Manufacturing produces standard wire hardware parts and specially designed wire forms. The company's products are used in a wide variety of applications, including appliance, communications, electromechanical, medical, recreational, and transportation industries.

Employing over 125 people in our 110,000 square foot plant in Cumberland, RI, our facility includes a wide range of production equipment, machinery to perform secondary operations, an extensive in-house tool room, and a modern quality control department. With our wide range of machinery, Hindley can fabricate parts that meet your specific needs. Our capabilities include forming wire in diameters from $\frac{1}{32}$ " to $\frac{9}{16}$ " and flat stock in various widths and diameters. Drawing wire from steel and stainless steel rod down to specific diameters for added cost savings on large volume orders. Additionally our fully automated machinery can economically produce both high and low volume orders.



PRODUCTION EQUIPMENT

Our product equipment includes the following:

- 75 4-Slides ranging in wire diameter from $\frac{1}{32}$ " to $\frac{9}{16}$ " diameter and feed lengths up to 32"
- 5 Forming and Thread Machines that can manufacture parts from $\frac{3}{16}$ " to $\frac{5}{8}$ " diameter, lengths up to 26"
- 2 OMCG Model 1200 with capability of 250 forming slides, up to $\frac{5}{16}$ " diameter wire with unlimited feed lengths.
- 1 OMCG CNC 16 three-dimensional forming requires no tooling, up to $\frac{5}{16}$ " diameter wire.

SECONDARY OPERATIONS

Our specialized equipment allows us to perform a wide range of secondary operations such as threading, broaching, chamfering, knurling, pointing, groove rolling, swaging, drilling and tapping, milling, flattening, welding, punching, slotting, stamping and wire shaping.

- 28 Presses ranging from 10 to 250 tons
- 47 Threaders with the capacity to produce 4-40 to $\frac{1}{2}$ -13 thread
- 4 Welders
- 1 Automatic Sawing, Drilling and Tapping Machine

TOOL ROOM

Our experienced toolmakers produce the tools necessary to manufacture your special wire parts.

- | | | |
|---------------------|-----------|-----------------|
| 14 Milling Machines | 5 Lathes | 2 Saws |
| 4 Grinders | 2 Shapers | 3 Drill presses |

QUALITY CONTROL

Our quality control department employs modern testing equipment to measure and test all incoming and outgoing products. Statistical Process Controls are used to insure that your special wire parts meet your exact specifications.

- 4 Comparators
- 2 Rockwell Harness Testers
- 1 Dillon Tensile Tester

We invite your inquiries. Our trained sales staff is ready to assist you, call toll free 1-800-323-9031 with your requirements. You may fax or send us a print, drawing, sketch, or sample of the part. Our skilled designers and engineers can assist you in bringing your idea to completion. They use the latest CAD technology to insure accuracy and satisfaction.

For more information about our wire forming capabilities or to obtain our Special Wire Parts brochure, call or write today.

hindley.

MAIN OFFICE

Hindley Mfg. Co., Inc.

P.O. Box 38

9 Havens Street

Cumberland, RI 02864-0838

Phone: (401) 722-2550

(800) 323-9031

Fax: (401) 722-3083

Internet: www.hindley.com

E-mail: hindley@hindley.com